

# Mobile Crane Grue automotrice

# LTM 1100-4.1

Technical Data  
Caractéristiques techniques

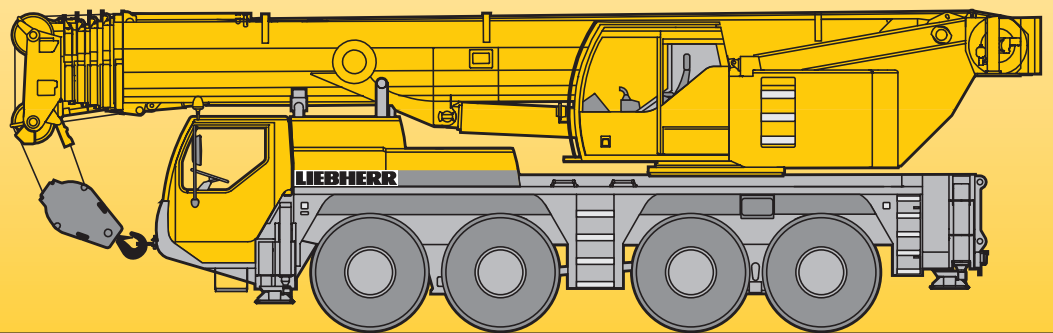

# LIEBHERR

# Lifting capacities on telescopic boom Forces de levage à la flèche télescopique

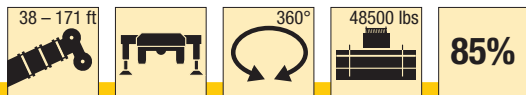

ft	ft												ft	
	38 ft	50 ft	62 ft	74 ft	87 ft	99 ft	111 ft	123 ft	135 ft	148 ft	160 ft	171 ft		
8	238												8	
9	230	201											9	
10	217	199											10	
11	205	188											11	
12	194	178	168	143									12	
13	184	168	167	143									13	
14	175	160	160	144	136	113							14	
15	166	152	152	144	136	113							15	
16	155	145	146	140	132	112	92.5						16	
17	146	139	139	136	129	111	92						17	
18	138	132	133	131	125	109	90.5	73.5	61				18	
20	122	120	120	120	117	105	88	73	61				20	
22	110	108	109	109	105	99	85.5	70.5	59.7	49.3			22	
24	99	98	99.5	98.5	95.5	92	83	68	58.2	48.9			24	
26	90	89	90.5	89.5	87.5	84.5	80	65	56.5	48	42.7		26	
28			83	81.5	81.5	77.5	73.5	62.5	54.5	46.9	42.2	32.9	28	
30			76	75	75.5	71.5	67.5	60	52.5	45.7	41.5	32.8	30	
32			70	69.5	69.5	66	62.5	57.7	50.6	44.2	40.7	32.2	26	32
34			65	65	64.5	61.5	58	54.9	48.6	42.7	39.6	31.7	25.7	34
36			61	61.5	60.5	57.3	54.4	51.8	46.7	41.3	38.4	31.1	25.3	36
38			56.9	57.7	56	53.2	50.7	48.7	44.8	39.9	37.2	30.6	24.8	38
40				54.1	52.2	49.6	47.5	45.9	42.9	38.5	36.1	30.1	24.4	40
45				45.8	44.9	42.6	41.6	40.3	37.8	35.4	33.5	28.8	23.3	45
50				39.2	39	37.1	37.1	35.4	33.2	32.2	30.5	27.6	22.3	50
55					34	32.8	33	31.3	29.6	28.9	27.9	26.2	21.5	55
60						29.3	29.4	28.1	26.9	25.8	25.7	24.5	20.6	60
65						25.8	26.3	25.4	24.4	24	23.3	21.8	19.7	65
70						22.9	23.5	23.3	22.1	21.9	21	19.6	18.6	70
75							21	21.3	20.3	19.9	19	17.7	17.2	75
80							19.2	19.2	18.8	18.1	17.2	15.9	15.7	80
85							18	17.2	16.9	16.2	15.5	14.4	14.2	85
90								15.8	15.4	14.6	13.9	12.9	12.7	90
95								14.5	13.9	13.2	12.5	11.6	11.5	95
100									12.7	12	11.4	10.5	10.4	100
105									11.7	11	10.4	9.5	9.4	105
110									10.9	10.1	9.5	8.6	8.5	110
115										9.3	8.7	7.8	7.7	115
120										8.6	8	7.1	7	120
125											7.3	6.4	6.3	125
130											6.7	5.8	5.7	130
135											6.1	5.2	5.1	135
140												4.6	4.6	140
145													4	145
150													3.5	150
155													2.9	155

\* over rear / en arrière

TAB 140190 / 140437

## Remarks referring to load charts

1. The tabulated lifting capacities do not exceed 85% of the tipping load.
2. The crane's structural steelwork is in accordance with DIN 15018, part 3. Design and construction of the crane comply with DIN 15018, part 2, and with F. E. M. regulations.
3. The 85% overturning limit values take into account wind force 5 = wind speed 20 mph.
4. Lifting capacities are given in kips.
5. The weight of the hook blocks and hooks must be deducted from the lifting capacities.
6. Working radii are measured from the slewing centreline.
7. The lifting capacities given for the telescopic boom only apply if the folding jib is taken off.
8. Lifting capacities are subject to modifications.
9. Lifting capacities above 183 kips only with special equipment.

# Lifting capacities on telescopic boom Forces de levage à la flèche télescopique





	38 – 171 ft		360°		25400 lbs		85%													
ft	38 ft	50 ft	62 ft	74 ft	87 ft	99 ft	111 ft	123 ft	135 ft	148 ft	160 ft	171 ft	ft							
9	197												9							
10	195												10							
11	184	168											11							
12	174	167	143										12							
13	165	164	143										13							
14	156	156	144	136	113								14							
15	147	147	143	134	113								15							
16	139	139	136	124	112	92.5							16							
17	131	131	127	117	108	91.5							17							
18	123	124	118	110	103	89.5	73.5	61					18							
20	108	109	100	98	91.5	84.5	72.5	61					20							
22	96.5	95.5	90.5	86.5	81	75.5	68.5	59.7	49.3				22							
24	86.5	84	81.5	77	72	67.5	63.5	57.2	48.9				24							
26	77.5	75	72.5	69	65	61	57.7	53.7	48	42.7			26							
28		68	65.5	62.5	59	56.4	53.7	50.1	46.1	42.2	32.9		28							
30		61.5	59.6	57	53.8	52.1	50	46.7	44	41.2	32.8		30							
32		56.2	54.6	52.3	49.8	48.8	46.1	43.4	41.6	39.1	32.2	26	32							
34		51.7	50.5	48.4	46.3	45.6	43	40.6	39.1	37.1	31.7	25.7	34							
36		47.5	47	45.1	43.1	42.6	40.4	38.2	36.6	35.2	31.1	25.3	36							
38		43.4	43.5	41.7	39.9	39.5	37.8	35.8	34	33.3	30.6	24.8	38							
40			40.3	38.8	37	36.8	35.4	33.6	31.8	31.4	29.7	24.4	40							
45			34	34.3	31.5	31.5	31	29.9	28.4	27.1	25.4	23.3	45							
50			29	29.8	27.1	28	27.1	26.1	24.8	23.5	21.8	21	50							
55				25.7	23.8	24.9	23.7	22.7	21.6	20.4	18.8	18.5	55							
60					21.6	21.9	20.8	19.9	18.9	17.8	16.3	16	60							
65					19.2	19.2	18.4	17.6	16.6	15.6	14.2	14	65							
70					16.9	16.9	16.3	15.7	14.8	13.8	12.5	12.2	70							
75						15	14.3	13.8	13	12.2	10.9	10.7	75							
80						13.3	12.6	12.1	11.5	10.8	9.6	9.4	80							
85						11.9	11.3	10.8	10.2	9.5	8.4	8.2	85							
90							10.2	9.7	9.1	8.4	7.3	7.2	90							
95							9.2	8.7	8.1	7.4	6.4	6.2	95							
100								7.9	7.2	6.6	5.5	5.4	100							
105								7.1	6.4	5.8	4.8	4.6	105							
110								6.4	5.7	5.1	4.1	4	110							
115									5.1	4.5	3.5	3.3	115							
120									4.4	3.9	2.9	2.8	120							
125										3.3			125							
130										2.7			130							
135										2.2			135							

TAB 140307





## Remarques relatives aux tableaux des charges

1. Les forces de levage indiquées ne dépassent pas 85% de la charge de basculement.
2. La norme DIN 15018, 3ème partie est appliquée pour les charpentes. La construction de la grue est réalisée conformément à la norme DIN 15018, 2ème partie, et aux règles de la F. E. M.
3. A 85% de la charge de basculement, il a été tenu compte d'un vent de force 5 = vitesse de vent 20 mph.
4. Les forces de levage sont données en kips.
5. Les poids des mouffes et crochets doit être soustrait des charges indiquées.
6. Les portées sont calculées à partir de l'axe de rotation.
7. Les forces indiquées pour la flèche télescopique s'entendent fléchette dépliée.
8. Les forces de levage sont modifiables sans préavis.
9. Forces de levage plus de 183 kips seulement avec équipement supplémentaire.

# Lifting capacities on telescopic boom Forces de levage à la flèche télescopique

    <b>85%</b>													
ft	38 ft	50 ft	62 ft	74 ft	87 ft	99 ft	111 ft	123 ft	135 ft	148 ft	160 ft	171 ft	ft
9	178												9
10	176												10
11	167	152											11
12	157	151	130										12
13	148	147	130	124									13
14	140	140	129	121	103								14
15	132	131	126	115	102								15
16	123	123	117	106	97.5	84.5							16
17	115	116	109	99	93	82.5							17
18	108	109	101	94	88	79	66.5	55.6					18
20	94.5	95	86	84.5	78	72	65.5	55.4					20
22	84	83	78.5	75	69.5	64.5	59.9	53.6	44.8				22
24	73.5	73.5	71	66.5	62	58.2	55	50.8	44.3				24
26	63	66	63.5	59.8	55.9	52.5	50.9	47	43.4	38.9			26
28		58.5	57.5	54.5	51.2	49.1	46.8	43.3	41	37.6	29.9		28
30		51.6	52.1	49.6	47	46	43	39.9	38.3	35.9	29.8		30
32		46.2	47.4	45.5	43.2	42.4	40.2	37.6	35.5	33	29.3	23.6	32
34		41.9	43.3	42.2	40	39.4	37.6	35.4	33.2	31	28.3	23.4	34
36		38.3	39.7	39.4	37.2	36.7	35	33.3	31.4	29.5	27.1	23	36
38		34.7	36.1	36.6	34.3	34	32.4	31.3	29.6	28	25.9	22.6	38
40			32.9	33.9	31.8	31.6	30.2	29.3	27.9	26.5	24.5	22.1	40
45			27.1	28.4	26.7	27.6	26.5	25.3	23.9	22.5	20.8	20	45
50			22.7	23.9	23.5	24	23	21.9	20.7	19.4	17.8	17.3	50
55				20.3	20.5	20.8	20	19	17.9	16.7	15.2	14.8	55
60					17.6	17.8	17.5	16.6	15.6	14.5	13.1	12.7	60
65					15.3	15.5	15.2	14.6	13.6	12.6	11.3	11	65
70					13.4	13.6	13.2	12.7	11.9	11	9.8	9.5	70
75						12	11.5	11.1	10.5	9.7	8.4	8.2	75
80						10.6	10.2	9.8	9.2	8.4	7.2	7	80
85						9.4	9	8.6	8	7.4	6.2	6	85
90							7.9	7.6	7.1	6.4	5.3	5.1	90
95							7	6.7	6.2	5.6	4.5	4.3	95
100								5.9	5.4	4.8	3.7	3.6	100
105								5.1	4.6	4.1			105
110								4.5	4	3.4			110
115									3.4	2.9			115
120									2.8				120

TAB 140313

    <b>85%</b>													
ft	38 ft	50 ft	62 ft	74 ft	87 ft	99 ft	111 ft	123 ft	135 ft	148 ft	160 ft	171 ft	ft
9	176												9
10	174												10
12	154	150	128	114									12
14	134	131	117	105	94.5								14
16	116	108	97	92.5	85.5	75							16
18	99	93	85	81	74	67.5	56.5	52.6					18
21	77	73	70.5	65.5	60.5	56.1	52.9	48.9	41.8				21
24	60.5	60.5	58.1	54.6	51.1	49.5	45.7	42.8	39.7	33.2			24
27		50.5	49	46.2	43.3	42.2	39.7	36.7	34.1	32.5	27.6		27
30		41.9	41.7	41.4	37.1	36.4	35.2	33.5	31.3	29.5	27.1	23.1	30
33		35.1	36.4	36	32.2	33.1	31.4	29.6	27.8	25.9	23.8	23	33
36		30.3	31.8	32.1	29.5	29.8	28.2	26.6	24.9	23.2	21.2	20.5	36
39		25.5	27.1	28.2	27.1	26.4	24.9	23.5	22.1	20.6	18.7	18.1	39
45			20.9	22.1	22.1	21.5	20.2	19.1	17.9	16.6	14.9	14.5	45
51			16.5	17.7	17.9	17.8	16.7	15.7	14.6	13.5	12	11.6	51
57				14.4	14.6	14.7	13.9	13	12.1	11	9.6	9.4	57
63					12.1	12.2	11.6	10.9	10	9	7.7	7.5	63
69					10	10.2	9.6	9.1	8.3	7.4	6.2	6	69
75						8.6	8.1	7.7	6.9	6	4.8	4.6	75
81						7.1	6.8	6.4	5.7	4.8			81
87							5.6	5.3	4.6	3.8			87
93							4.6	4.3	3.7				93
99								3.5					99
105								2.7					105
111								2.1					111

TAB 140316

# Lifting capacities on telescopic boom

## Forces de levage à la flèche télescopique

		38 - 62 ft		0°		48500 lbs		85%	
		38 ft		50 ft		62 ft			
ft		ft		ft		ft		ft	
9		55.6							9
10		55							10
11		51.5		51.9		53.2			11
12		48.2		50.4		51.6			12
13		45.2		47.4		48.6			13
14		42.6		44.8		46			14
15		40.1		42.3		43.6			15
16		37.9		40.1		41.3			16
17		35.9		38.1		39.3			17
18		34.1		36.3		37.5			18
20		30.5		32.7		34			20
22		27.6		29.8		31.1			22
24		25		27.2		28.5			24
26		22.7		24.9		26.1			26
28				22.9		24.1			28
30				21		22.3			30
32				19.4		20.6			32
34				18		19.2			34
36				16.7		17.9			36
38				15.4		16.6			38
40						15.5			40
45						13			45
50						11.1			50

0° = over rear / en arrière

tyre size / dimensions de pneumatiques: 16.00 R 25 / 20.5 R 25

TAB 140178

		38 - 62 ft		0°		25400 lbs		85%	
		38 ft		50 ft		62 ft			
ft		ft		ft		ft		ft	
9		51.8							9
10		51.3							10
11		48		48.5		49.7			11
12		44.9		47		48.3			12
13		42		44.2		45.4			13
14		39.6		41.7		43			14
15		37.2		39.4		40.6			15
16		35.1		37.3		38.5			16
17		33.2		35.4		36.6			17
18		31.5		33.7		34.9			18
20		28.1		30.3		31.6			20
22		25		27.6		28.8			22
24		22		24.8		26.2			24
26		18.8		21.9		23.7			26
28				19.4		21.2			28
30				17.1		18.9			30
32				15.2		16.9			32
34				13.5		15.2			34
36				12.1		13.8			36
38				10.7		12.3			38
40						11			40
45						8.5			45
50						6.6			50

0° = over rear / en arrière

tyre size / dimensions de pneumatiques: 16.00 R 25 / 20.5 R 25

TAB 140179

# Lifting heights Hauteurs de levage

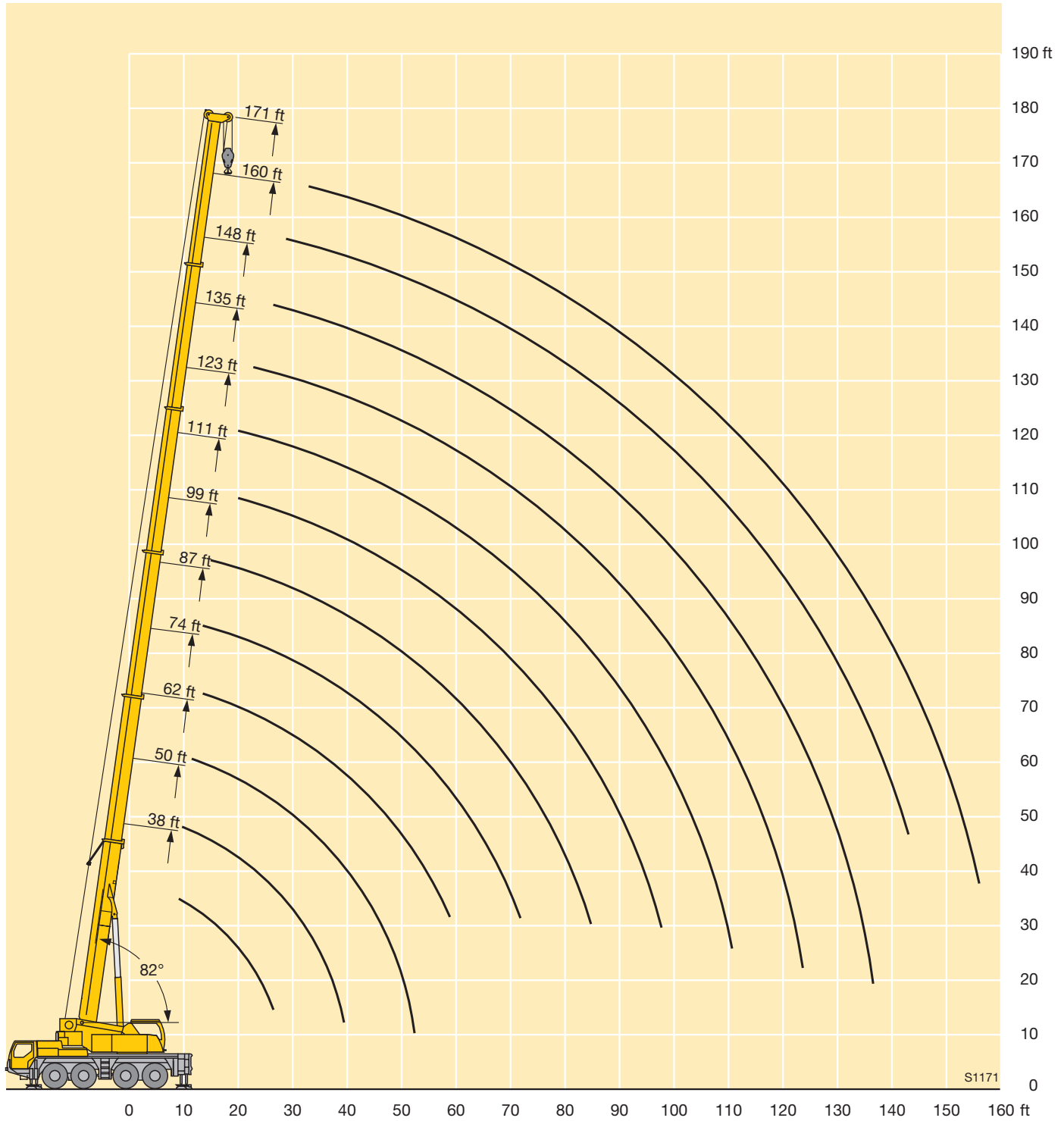

# Lifting capacities on the folding jib

## Forces de levage à la fléchette pliante



ft	38 ft			123 ft			135 ft			148 ft			160 ft			171 ft			ft		
	0°	20°	40°	0°	20°	40°	0°	20°	40°	0°	20°	40°	0°	20°	40°	0°	20°	40°			
9	30.9																		9		
10	30.8																		10		
11	30.3																		11		
12	29.9																		12		
13	29.4																		13		
14	28.8																		14		
15	28.3																		15		
16	27.7	26.9																	16		
17	27.1	26.6																	17		
18	26.6	26																	18		
20	25.3	25																	20		
22	24	23.9		33															22		
24	22.7	22.9		32.7															24		
26	21.5	21.9	20.9	32.2			29.3												26		
28	20.3	21.1	20.2	31.7			29			23.3					18.9				28		
30	19.2	20.2	19.5	31.2			28.6			23.2					18.8				30		
32	18.3	19.5	18.8	30.8			28.3			22.9					18.5			15.2	32		
34	17.4	18.7	18.2	30.4			28			22.5					18.2			15	34		
36	16.7	18	17.7	29.9			27.7			22.2					17.9			14.8	36		
38	15.9	17.3	17.1	29.5	25.6		27.4	24.5		21.9					17.6			14.5	38		
40	15.1	16.5	16.6	29	25.5		27	24.4		21.6					17.3			14.2	40		
45	13.6	14.7	15.5	27.7	24.3	21	26.1	23.5		20.8	19.4				16.8	16		13.6	12.9	45	
50	12.2	13.2	14	26.4	23.2	20.3	24.9	22.7	19.7	20.1	18.8	17.9			16.2	15.4		13.1	12.5	50	
55	11.2	11.9	12.9	25	22.1	19.5	23.5	21.8	19.4	19.3	18.1	17.5			15.6	14.8	14	12.6	12	11.5	55
60				23.4	21.1	18.8	22	20.9	18.7	18.5	17.4	16.8			15	14.3	14	12.1	11.6	11.4	60
65				21.4	20.2	18.1	19.9	20.1	18.1	17.8	16.7	16.2			14.4	13.7	13.5	11.7	11.2	11	65
70				19.3	19.4	17.6	18	18.9	17.6	17.1	16.1	15.6			13.9	13.3	13.1	11.2	10.8	10.6	70
75				17.4	18.2	17	16.6	17.2	17.1	15.8	15.5	15.1			13.4	12.8	12.7	10.8	10.4	10.3	75
80				15.6	16.7	16.5	15.5	15.6	16.3	14.2	14.8	14.6			12.9	12.4	12.3	10.5	10	9.9	80
85				14.1	15.1	15.8	14	14.6	14.7	12.8	13.8	14.1			12.5	12	11.9	10.1	9.7	9.6	85
90				12.8	13.7	14.4	12.7	13.5	13.9	12.2	12.4	13.1			11.5	11.7	11.6	9.7	9.4	9.3	90
95				11.8	12.4	13	11.8	12.3	12.9	11.5	11.6	12			10.4	11.1	11.3	9.4	9.1	9	95
100				11.1	11.3	11.7	11.2	11.3	11.8	10.5	11	11.1			9.4	10.2	10.8	8.9	8.8	8.7	100
105				10.6	10.5	10.6	10.5	10.7	10.7	9.6	10.3	10.8			8.5	9.2	9.9	8.2	8.5	8.5	105
110				10.1	10.1	10.1	9.6	10	10.3	8.7	9.4	9.9			7.6	8.3	8.9	7.3	8	8.3	110
115				9.5	9.7	9.8	8.7	9.2	9.6	7.9	8.5	9			6.9	7.5	8	6.6	7.3	7.7	115
120				8.7	9.1	9.3	8	8.4	8.7	7.2	7.8	8.2			6.1	6.8	7.2	5.9	6.5	7	120
125				8	8.3	8.5	7.3	7.7	7.9	6.6	7.1	7.4			5.5	6	6.5	5.2	5.8	6.3	125
130				7.4	7.7	7.8	6.7	7	7.2	6	6.4	6.7			4.9	5.4	5.8	4.6	5.2	5.6	130
135				6.8	7	7.1	6.1	6.4	6.6	5.4	5.8	6.1			4.3	4.8	5.1	4.1	4.6	5	135
140				6.2	6.4		5.5	5.8	5.9	4.8	5.2	5.4			3.8	4.3	4.5	3.5	4	4.4	140
145							4.9	5.2		4.3	4.6	4.8			3.3	3.7	4	3.1	3.5	3.8	145
150							4.4	4.6		3.8	4.1	4.2			2.8	3.2	3.5	2.6	3	3.3	150
155							4	4.1		3.3	3.6	3.6			2.4	2.7	2.9	2.2	2.6	2.8	155
160										2.8	3.1					2.3	2.4		2.2	2.3	160
165										2.5											165
170										2.1											170

TAB 140431 / 140433 / 140435

# Lifting capacities on the folding jib

## Forces de levage à la fléchette pliante



ft	38 ft			123 ft			135 ft			148 ft			160 ft			171 ft			ft
	62 ft			62 ft			62 ft			62 ft			62 ft			62 ft			
	0°	20°	40°	0°	20°	40°	0°	20°	40°	0°	20°	40°	0°	20°	40°	0°	20°	40°	
13	12.3																		13
14	12.2																		14
15	12.1																		15
16	11.9																		16
17	11.7																		17
18	11.6																		18
20	11.3																		20
22	10.9																		22
24	10.6																		24
26	10.3			12.6															26
28	10	8.6		12.5			12												28
30	9.7	8.5		12.4			12												30
32	9.5	8.3		12.3			11.9			11.1									32
34	9.2	8.1		12.2			11.8			11.1									34
36	9	7.9		12			11.7			11									36
38	8.7	7.8		11.8			11.6			10.9			9.9			8.7			38
40	8.5	7.6		11.7			11.4			10.8			9.9			8.7			40
45	8.1	7.3		11.2			11.1			10.6			9.7			8.5			45
50	7.7	7	6.3	10.8	8.3		10.7	8.2		10.3			9.5			8.3			50
55	7.4	6.7	6.2	10.4	8.1		10.3	8.1		10	7.8		9.3	7.5		8.2			55
60	7.1	6.5	6.1	10	7.9		9.9	7.9		9.6	7.7		9	7.5		8			60
65	6.8	6.4	6	9.6	7.7	6.5	9.6	7.7		9.3	7.5		8.8	7.3		7.8	7.1		65
70	6.6	6.3	6	9.3	7.5	6.4	9.3	7.5	6.4	9	7.4	6.3	8.6	7.2		7.8	7		70
75	6.5	6.2	6	9	7.3	6.3	9	7.3	6.3	8.8	7.2	6.3	8.4	7	6.1	7.7	6.9	6	75
80	6.4	6.1	6	8.6	7.2	6.2	8.7	7.2	6.2	8.5	7.1	6.2	8.2	6.9	6.1	7.5	6.7	6	80
85	6.3	6.1	6	8.4	7	6.2	8.4	7	6.1	8.3	6.9	6.1	8	6.8	6	7.3	6.6	5.9	85
90				8.1	6.9	6.1	8.2	6.9	6.1	8.1	6.8	6	7.8	6.6	5.9	7.1	6.5	5.9	90
95				7.9	6.7	6	8	6.8	6	7.9	6.7	6	7.6	6.5	5.9	6.9	6.4	5.8	95
100				7.7	6.6	6	7.8	6.7	6	7.7	6.6	6	7.5	6.5	5.9	6.7	6.3	5.8	100
105				7.5	6.5	6	7.6	6.6	6	7.5	6.5	5.9	7.3	6.4	5.8	6.5	6.2	5.8	105
110				7.4	6.4	6	7.4	6.5	6	7.4	6.4	5.9	7.2	6.3	5.8	6.3	6.1	5.8	110
115				7.2	6.4	6	7.2	6.4	5.9	7.2	6.4	5.9	7	6.3	5.8	6.2	6	5.8	115
120				7.1	6.3	6	7.1	6.3	5.9	7	6.3	5.9	6.7	6.2	5.8	6	5.8	5.8	120
125				6.9	6.3	6	7	6.3	5.9	6.8	6.2	5.9	6.1	6.1	5.8	5.8	5.7	5.7	125
130				6.7	6.3	6	6.8	6.3	5.9	6.4	6.2	5.9	5.5	6.1	5.8	5.2	5.6	5.7	130
135				6.5	6.2	6	6.5	6.2	5.9	5.9	6.1	5.9	4.9	5.8	5.8	4.6	5.4	5.6	135
140				6.4	6.2	6	6.2	6.1	5.9	5.4	6	5.9	4.4	5.3	5.7	4.1	5.1	5.4	140
145				6.3	6.1	6	5.6	6	5.9	4.9	5.6	5.8	3.9	4.8	5.4	3.6	4.5	5.2	145
150				5.8	6.1	5.9	5.1	5.7	5.9	4.4	5.1	5.6	3.5	4.3	4.8	3.2	4	4.7	150
155				5.4	5.8	5.8	4.6	5.2	5.5	4	4.6	5.1	3	3.8	4.3	2.8	3.6	4.1	155
160				4.9	5.3	5.4	4.2	4.7	5	3.6	4.2	4.5	2.6	3.3	3.8	2.4	3.1	3.6	160
165				4.5	4.8		3.8	4.2	4.4	3.1	3.7	4	2.3	2.9	3.3		2.7	3.2	165
170				4.1	4.3		3.4	3.7	3.8	2.7	3.3	3.5	1.9	2.5	2.9		2.3	2.7	170
175							3	3.3		2.4	2.8	3		2.1	2.4		1.9	2.3	175
180							2.7	2.9		2	2.4	2.5							180

TAB 140431 / 140433 / 140435



# Lifting heights Hauteurs de levage

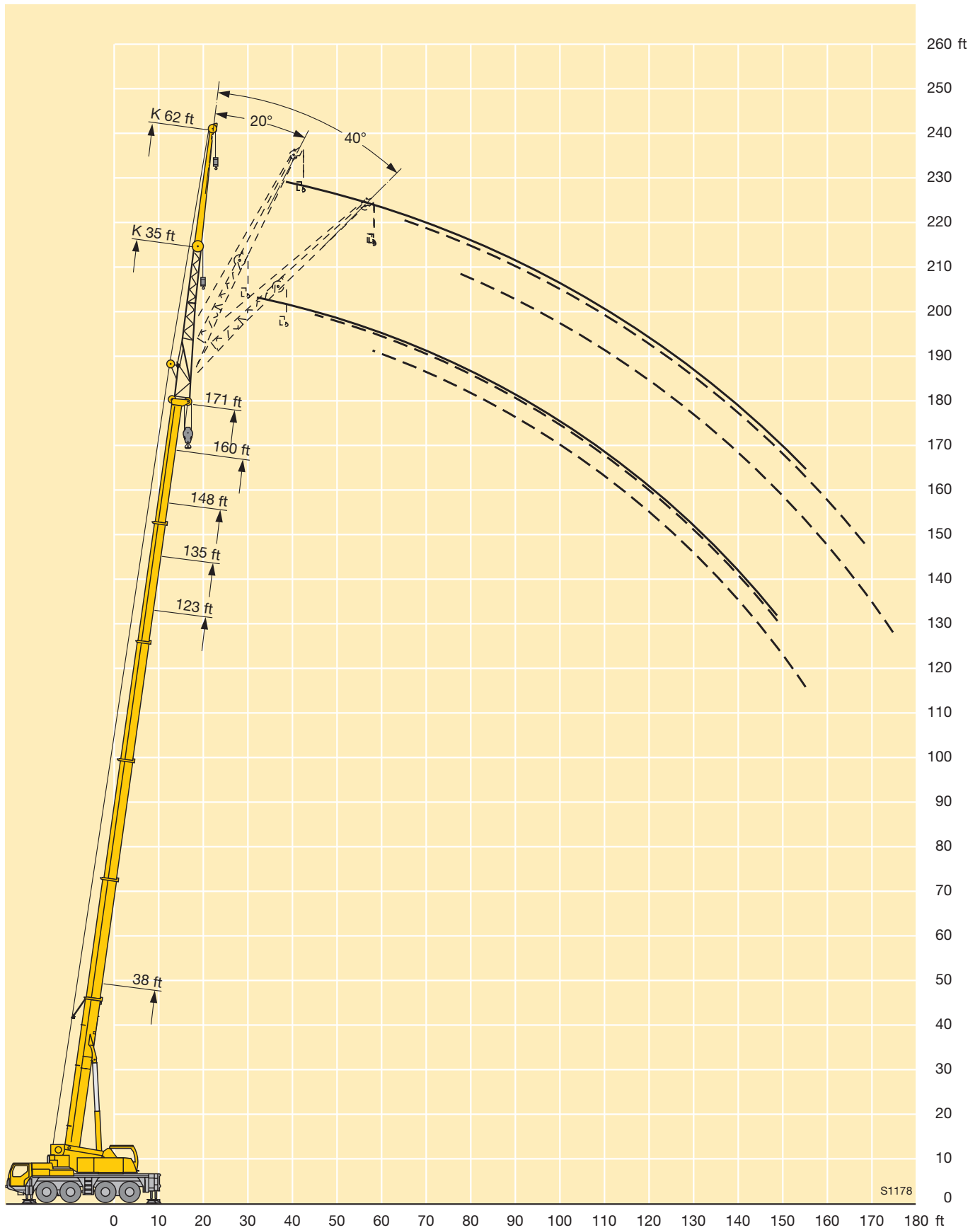

# Lifting capacities on the hydraulically variable folding jib

## Capacités de levage à la fléchette pliante à variation hydraulique



ft	38 ft			123 ft			135 ft			148 ft			160 ft			171 ft			ft
	35 ft			35 ft			35 ft			35 ft			35 ft			35 ft			
	0°	20°	40°	0°	20°	40°	0°	20°	40°	0°	20°	40°	0°	20°	40°	0°	20°	40°	
9	30.6																		9
10	30.5																		10
11	30.1																		11
12	29.6																		12
13	29.1																		13
14	28.6																		14
15	28.1																		15
16	27.5	26.8																	16
17	27	26.4																	17
18	26.4	25.9																	18
20	25.3	24.8																	20
22	24	23.7		32.7															22
24	22.7	22.7		32.4															24
26	21.4	21.8	20.9	31.8			29.1												26
28	20.3	20.9	20.1	31.3			28.8			23.1			18.6						28
30	19.2	20	19.3	30.8			28.4			23			18.6						30
32	18.2	19.3	18.7	30.4			28			22.6			18.3			15			32
34	17.3	18.6	18.1	29.9			27.7			22.3			18			14.8			34
36	16.6	17.8	17.6	29.5			27.4			22			17.7			14.6			36
38	15.8	17.1	17	29.1	25.3		27	24.3		21.6			17.4			14.3			38
40	15.1	16.4	16.5	28.6	25.2		26.7	24.2		21.3			17.1			14			40
45	13.5	14.6	15.4	27.4	24	20.8	25.8	23.3		20.6	19.3		16.5	15.8		13.4	12.8		45
50	12.1	13.1	13.9	26.1	22.9	20.1	24.6	22.4	19.5	19.8	18.6	17.7	16	15.3		12.9	12.4		50
55	11	11.7	12.9	24.7	21.8	19.3	23.3	21.6	19.2	19	17.9	17.4	15.4	14.7	13.9	12.4	11.9	11.4	55
60				23.2	20.8	18.6	21.8	20.7	18.5	18.2	17.2	16.7	14.7	14.1	13.8	11.9	11.5	11.3	60
65				21.3	19.9	18	19.8	19.9	18	17.6	16.5	16.1	14.2	13.6	13.4	11.5	11	10.9	65
70				19.1	19.1	17.4	17.8	18.7	17.4	16.8	15.9	15.5	13.7	13.1	13	11	10.6	10.5	70
75				17.2	18	16.9	16.4	17.1	16.9	15.6	15.3	14.9	13.2	12.7	12.6	10.7	10.2	10.1	75
80				15.4	16.5	16.4	15.3	15.4	16.2	14	14.6	14.4	12.8	12.3	12.2	10.3	9.9	9.8	80
85				13.9	14.9	15.6	13.8	14.4	14.6	12.6	13.6	14	12.3	11.9	11.8	9.9	9.5	9.5	85
90				12.6	13.5	14.2	12.5	13.3	13.8	12.1	12.2	12.9	11.3	11.5	11.5	9.6	9.2	9.1	90
95				11.6	12.2	12.8	11.6	12.1	12.8	11.3	11.4	11.9	10.2	10.9	11.2	9.2	8.9	8.9	95
100				11	11.1	11.6	11	11.1	11.6	10.3	10.8	11	9.2	10	10.6	8.8	8.7	8.6	100
105				10.5	10.3	10.4	10.2	10.5	10.5	9.4	10.1	10.6	8.2	9	9.6	7.9	8.4	8.4	105
110				10	10	10	9.4	9.8	10.1	8.5	9.1	9.6	7.4	8.1	8.7	7.1	7.8	8.1	110
115				9.3	9.5	9.6	8.5	9	9.4	7.7	8.3	8.7	6.6	7.3	7.8	6.3	7	7.5	115
120				8.5	8.9	9.1	7.8	8.2	8.5	7	7.5	7.9	5.9	6.5	7	5.6	6.3	6.8	120
125				7.8	8.1	8.3	7.1	7.5	7.7	6.3	6.8	7.1	5.2	5.8	6.2	5	5.6	6	125
130				7.2	7.5	7.6	6.4	6.8	7	5.7	6.1	6.5	4.6	5.2	5.5	4.4	4.9	5.3	130
135				6.5	6.8	6.8	5.8	6.2	6.3	5.1	5.5	5.8	4.1	4.6	4.9	3.8	4.3	4.7	135
140				6	6.1		5.2	5.5	5.6	4.6	5	5.2	3.5	4	4.3	3.3	3.8	4.1	140
145							4.6	4.9		4	4.4	4.5	3.1	3.5	3.7	2.8	3.2	3.5	145
150							4.1	4.3		3.5	3.8	3.9	2.6	3	3.2	2.4	2.8	3	150
155							3.7	3.8		3	3.3	3.3	2.1	2.5	2.7		2.3	2.5	155
160										2.6	2.8				2.1				160
165										2.2									165
170										1.8									170

TAB 140507 / 140509 / 140511

# Lifting capacities on the hydraulically variable folding jib

## Capacités de levage à la fléchette pliante à variation hydraulique



ft	38 ft			123 ft			135 ft			148 ft			160 ft			171 ft			ft
	0°	20°	40°	0°	20°	40°	0°	20°	40°	0°	20°	40°	0°	20°	40°	0°	20°	40°	
13	12.3																		13
14	12.1																		14
15	11.9																		15
16	11.8																		16
17	11.6																		17
18	11.5																		18
20	11.2																		20
22	10.8																		22
24	10.5																		24
26	10.2			12.6															26
28	9.9	7.6		12.5			12												28
30	9.6	7.6		12.4			12												30
32	9.4	7.6		12.2			11.9			11.1									32
34	9.1	7.6		12			11.7			11									34
36	8.9	7.6		11.9			11.6			10.9									36
38	8.7	7.6		11.7			11.4			10.8			9.9			8.5			38
40	8.5	7.5		11.5			11.3			10.7			9.9			8.5			40
45	8	7.2		11.1			10.9			10.4			9.6			8.5			45
50	7.6	6.9	6.2	10.6	8.2		10.5	8.1		10.1			9.4			8.3			50
55	7.3	6.7	6.2	10.2	8		10.2	8		9.8	7.7		9.2	7.4		8.2			55
60	7	6.5	6	9.8	7.8		9.8	7.8		9.5	7.6		8.9	7.4		8			60
65	6.8	6.3	6	9.5	7.6	6.4	9.4	7.6		9.2	7.5		8.7	7.2		7.8	7		65
70	6.6	6.3	6	9.1	7.4	6.4	9.1	7.4	6.3	8.9	7.3	6.2	8.4	7.1		7.8	6.9		70
75	6.4	6.2	6	8.8	7.2	6.3	8.8	7.2	6.3	8.6	7.1	6.2	8.2	6.9	6	7.6	6.8	6	75
80	6.3	6.1	6	8.5	7.1	6.2	8.6	7.1	6.2	8.4	7	6.1	8	6.8	6	7.4	6.7	5.9	80
85	6.3	6.1	6	8.3	6.9	6.1	8.3	6.9	6.1	8.2	6.8	6	7.8	6.7	6	7.2	6.6	5.9	85
90				8	6.8	6.1	8.1	6.8	6	8	6.7	6	7.7	6.6	5.9	7	6.5	5.8	90
95				7.8	6.7	6	7.9	6.7	6	7.8	6.6	6	7.5	6.5	5.9	6.8	6.4	5.8	95
100				7.6	6.6	6	7.7	6.6	6	7.6	6.5	5.9	7.4	6.4	5.8	6.6	6.3	5.8	100
105				7.4	6.5	6	7.5	6.5	5.9	7.4	6.5	5.9	7.2	6.3	5.8	6.4	6.2	5.8	105
110				7.3	6.4	6	7.3	6.4	5.9	7.3	6.4	5.9	7.1	6.3	5.8	6.2	6.1	5.8	110
115				7.1	6.3	6	7.2	6.3	5.9	7.1	6.3	5.9	6.9	6.2	5.8	6.1	5.9	5.7	115
120				7	6.3	6	7	6.3	5.9	6.9	6.2	5.9	6.6	6.1	5.8	5.9	5.8	5.7	120
125				6.8	6.3	6	6.9	6.2	5.9	6.8	6.2	5.9	6.6	6.1	5.8	5.6	5.6	5.7	125
130				6.6	6.2	6	6.7	6.2	5.9	6.3	6.1	5.9	6.3	6.1	5.8	5	5.5	5.6	130
135				6.5	6.2	6	6.4	6.2	5.9	6.1	5.9	5.9	6.1	5.7	5.8	4.5	5.3	5.5	135
140				6.4	6.1	5.9	6	6.1	5.9	5.2	5.9	5.9	4.2	5.1	5.6	3.9	4.9	5.3	140
145				6.2	6.1	5.9	5.5	6	5.9	4.7	5.5	5.8	3.7	4.6	5.2	3.5	4.4	5.1	145
150				5.7	6.1	5.9	5	5.6	5.8	4.3	4.9	5.4	3.3	4.1	4.7	3	3.9	4.5	150
155				5.2	5.6	5.6	4.5	5	5.3	3.8	4.5	4.9	2.8	3.6	4.1	2.6	3.4	4	155
160				4.7	5.1	5.1	4	4.5	4.8	3.4	4	4.3	2.4	3.1	3.6	2.2	2.9	3.5	160
165				4.3	4.6		3.6	4	4.2	2.9	3.5	3.8		2.7	3.1		2.5	3	165
170				3.9	4.1		3.2	3.5	3.6	2.5	3.1	3.3		2.3	2.6		2.1	2.5	170
175							2.8	3.1		2.2	2.6	2.8		1.9	2.2		2.1		175
180							2.4	2.7				2.2	2.3						180

TAB 140507 / 140509 / 140511

# Lifting heights Hauteurs de levage

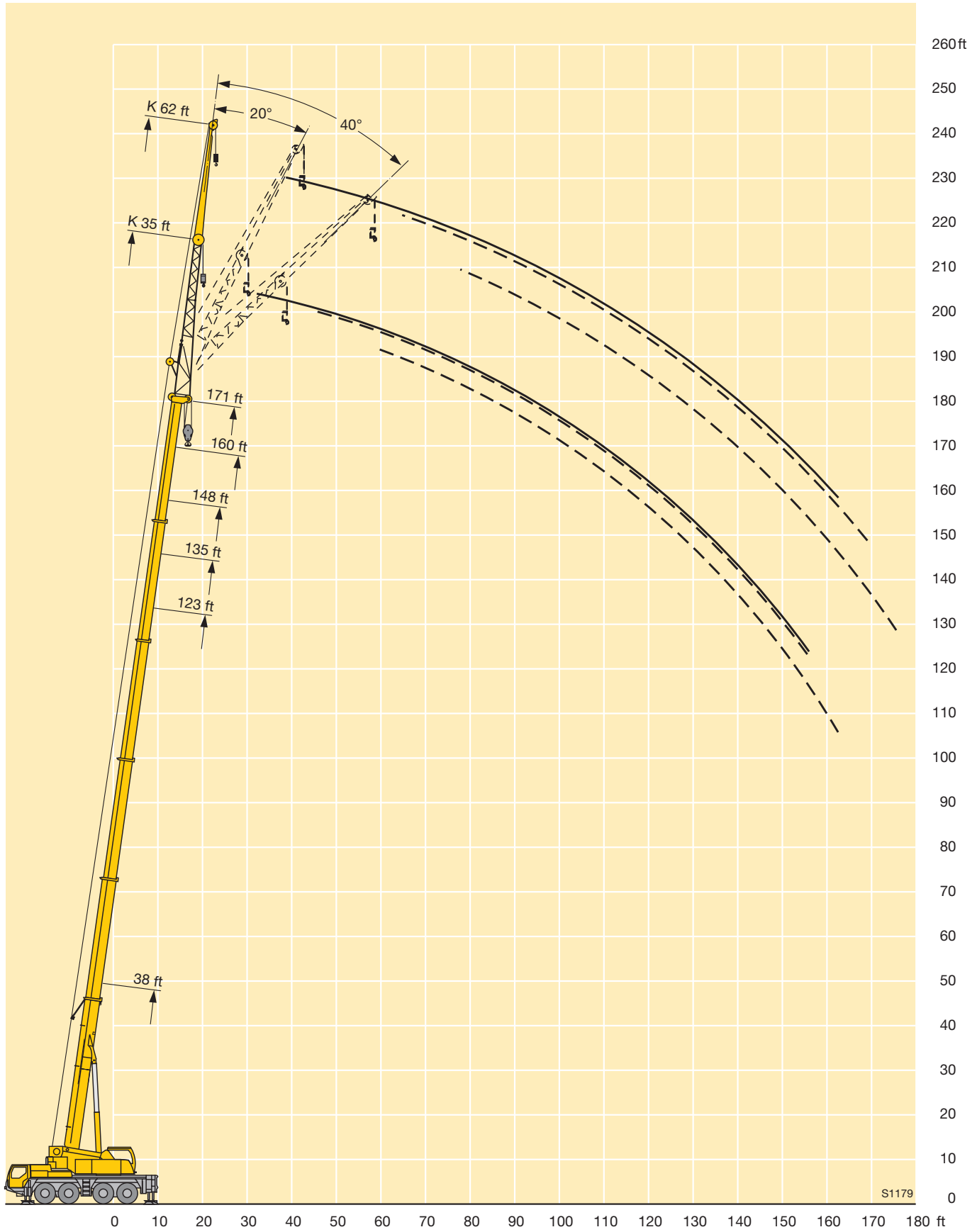

S1179

# Lifting capacities on the folding jib with boom extension

## Forces de levage à la flèche pliante avec télescope rallongé



ft	38 ft + 23 ft			135 ft + 23 ft			148 ft + 23 ft			160 ft + 23 ft			171 ft + 23 ft			ft
	35 ft			35 ft			35 ft			35 ft			35 ft			
	0°	20°	40°	0°	20°	40°	0°	20°	40°	0°	20°	40°	0°	20°	40°	
13	13.6															13
14	13.4															14
15	13.1															15
16	13															16
17	12.8															17
18	12.6	12.3														18
20	12.2	12.2														20
22	11.8	11.9														22
24	11.5	11.5														24
26	11.1	11.1		14.6												26
28	10.8	10.7	10.2	14.4			13.4									28
30	10.4	10.4	10.2	14.2			13.3									30
32	10.1	10.1	10	13.9			13.2			12.2						32
34	9.8	9.8	9.7	13.7			13			12.1						34
36	9.5	9.5	9.5	13.5			12.8			11.9						36
38	9.2	9.2	9.2	13.3	12.3		12.6			11.8			9.8			38
40	8.9	8.9	8.9	13.1	12.2		12.4			11.7			9.8			40
45	8.3	8.3	8.3	12.6	11.7		12	11.2		11.3	10.7		9.4			45
50	7.8	7.8	7.8	12.1	11.2	10.2	11.6	10.9	10	11	10.4		9.1	8.6		50
55	7.3	7.3	7.3	11.7	10.8	10	11.3	10.5	9.9	10.7	10.1	9.3	8.8	8.5	8	55
60	6.9	6.9	6.9	11.2	10.4	9.7	10.9	10.1	9.5	10.3	9.8	9.2	8.5	8.2	8	60
65	6.5	6.6	6.5	10.8	10	9.3	10.5	9.8	9.2	10	9.5	8.9	8.2	7.9	7.7	65
70	6.1	6.2	6.2	10.4	9.6	9	10.1	9.5	8.9	9.7	9.2	8.7	7.9	7.6	7.4	70
75	5.7	5.8	6	10	9.3	8.7	9.8	9.2	8.6	9.4	8.9	8.4	7.6	7.4	7.2	75
80	5.4	5.5		9.6	8.9	8.5	9.5	8.9	8.4	9.1	8.6	8.2	7.3	7.1	6.9	80
85	4.9	5.1		9.2	8.6	8.2	9.2	8.6	8.1	8.8	8.4	8	7.1	6.8	6.7	85
90				8.9	8.4	7.9	8.9	8.3	7.9	8.6	8.1	7.8	6.9	6.6	6.5	90
95				8.6	8.1	7.7	8.5	8.1	7.7	8.3	7.9	7.6	6.6	6.4	6.2	95
100				8.3	7.9	7.5	8.3	7.9	7.5	8.1	7.7	7.4	6.4	6.2	6	100
105				8	7.6	7.3	8	7.7	7.3	7.9	7.5	7.2	6.2	6	5.8	105
110				7.8	7.4	7.1	7.8	7.4	7.1	7.4	7.3	7	6	5.8	5.7	110
115				7.5	7.2	6.9	7.5	7.2	7	6.7	7.1	6.9	5.9	5.6	5.5	115
120				7.3	7	6.8	7	7	6.8	6	6.6	6.7	5.5	5.5	5.4	120
125				7	6.9	6.7	6.3	6.9	6.6	5.3	5.9	6.4	5	5.3	5.2	125
130				6.5	6.7	6.5	5.7	6.2	6.5	4.7	5.3	5.7	4.4	5	5.1	130
135				5.9	6.3	6.4	5.1	5.6	6	4.1	4.7	5.1	3.9	4.4	4.8	135
140				5.4	5.8	6	4.6	5.1	5.4	3.6	4.1	4.5	3.3	3.9	4.3	140
145				4.9	5.2		4.1	4.5	4.8	3.1	3.6	3.9	2.9	3.4	3.7	145
150				4.3	4.7		3.7	4	4.3	2.7	3.1	3.4	2.4	2.9	3.2	150
155				3.8	4.2		3.2	3.6	3.8	2.3	2.7	2.9		2.4	2.7	155
160				3.4	3.7		2.8	3.1			2.2	2.5			2.3	160
165				3	3.2		2.3	2.7								165
170				2.6	2.8		1.9	2.2								170
175				2.2	2.4											175

TAB 140287 / 140289 / 140291

# Lifting capacities on the folding jib with boom extension

## Forces de levage à la fléchette pliante avec télescope rallongé



ft	38 ft + 23 ft			135 ft + 23 ft			148 ft + 23 ft			160 ft + 23 ft			171 ft + 23 ft			ft
	62 ft			62 ft			62 ft			62 ft			62 ft			
	0°	20°	40°	0°	20°	40°	0°	20°	40°	0°	20°	40°	0°	20°	40°	
18	9															18
20	9															20
22	8.9															22
24	8.7															24
26	8.6															26
28	8.4			9.3												28
30	8.2			9.3												30
32	8	7.6		9.3			8.8									32
34	7.9	7.6		9.2			8.8									34
36	7.7	7.5		9.2			8.8									36
38	7.5	7.5		9.2			8.7			8.3						38
40	7.3	7.4		9.1			8.7			8.2						40
45	6.9	7		9			8.6			8.1			6.9			45
50	6.5	6.6	6.4	8.8			8.4			7.9			6.7			50
55	6.1	6.2	6.3	8.5	7.6		8.2	7.5		7.8			6.5			55
60	5.8	5.9	6	8.3	7.6		8	7.5		7.6			6.3			60
65	5.5	5.6	5.7	8	7.4		7.8	7.3		7.4	7		6.1	5.9		65
70	5.2	5.3	5.4	7.8	7.2	6.4	7.6	7.1		7.3	6.8		5.9	5.8		70
75	5	5	5.1	7.5	7	6.4	7.3	6.8	6.3	7	6.6	6	5.7	5.6		75
80	4.8	4.8	4.9	7.3	6.7	6.3	7.1	6.6	6.3	6.8	6.4	6	5.6	5.4		80
85	4.6	4.6	4.7	7.1	6.5	6.2	6.9	6.4	6.1	6.7	6.3	6	5.4	5.3	5.2	85
90	4.4	4.4	4.5	6.8	6.3	6	6.7	6.2	6	6.5	6.1	5.8	5.2	5.1	5	90
95	4.2	4.2	4.3	6.6	6.1	5.9	6.5	6	5.8	6.3	5.9	5.7	5	5	4.9	95
100	4	4.1	4.2	6.4	5.9	5.7	6.3	5.9	5.7	6.1	5.8	5.5	4.9	4.8	4.8	100
105	3.8	3.9		6.2	5.8	5.6	6.1	5.7	5.5	6	5.6	5.4	4.7	4.7	4.6	105
110	3.7	3.7		6	5.6	5.4	6	5.6	5.4	5.8	5.5	5.3	4.6	4.5	4.5	110
115				5.8	5.4	5.3	5.8	5.4	5.2	5.7	5.3	5.2	4.5	4.4	4.4	115
120				5.7	5.3	5.1	5.7	5.3	5.1	5.6	5.2	5.1	4.3	4.3	4.3	120
125				5.5	5.2	5	5.5	5.2	5	5.4	5.1	4.9	4.2	4.1	4.2	125
130				5.3	5	4.9	5.4	5.1	4.9	4.9	5	4.9	4.1	4	4.1	130
135				5.2	4.9	4.8	5.2	4.9	4.8	4.4	4.9	4.8	3.9	3.9	4	135
140				5	4.8	4.7	4.9	4.8	4.7	3.9	4.7	4.7	3.6	3.8	3.9	140
145				4.9	4.7	4.6	4.4	4.7	4.6	3.4	4.4	4.6	3.1	3.7	3.8	145
150				4.6	4.6	4.5	3.9	4.6	4.5	3	3.9	4.5	2.7	3.6	3.6	150
155				4.2	4.5	4.5	3.5	4.2	4.5	2.6	3.4	4	2.3	3.1	3.6	155
160				3.8	4.3	4.4	3.1	3.8	4.2	2.2	3	3.5		2.7	3.3	160
165				3.5	4	4.3	2.7	3.4	3.8		2.5	3.1		2.3	2.9	165
170				3.1	3.6	3.9	2.4	3	3.4		2.1	2.6		1.9	2.4	170
175				2.7	3.2		2	2.6	3			2.2			2	175
180				2.3	2.8			2.2	2.6							180
185					2.4											185
190					2											190

TAB 140287 / 140289 / 140291

# Lifting heights Hauteurs de levage

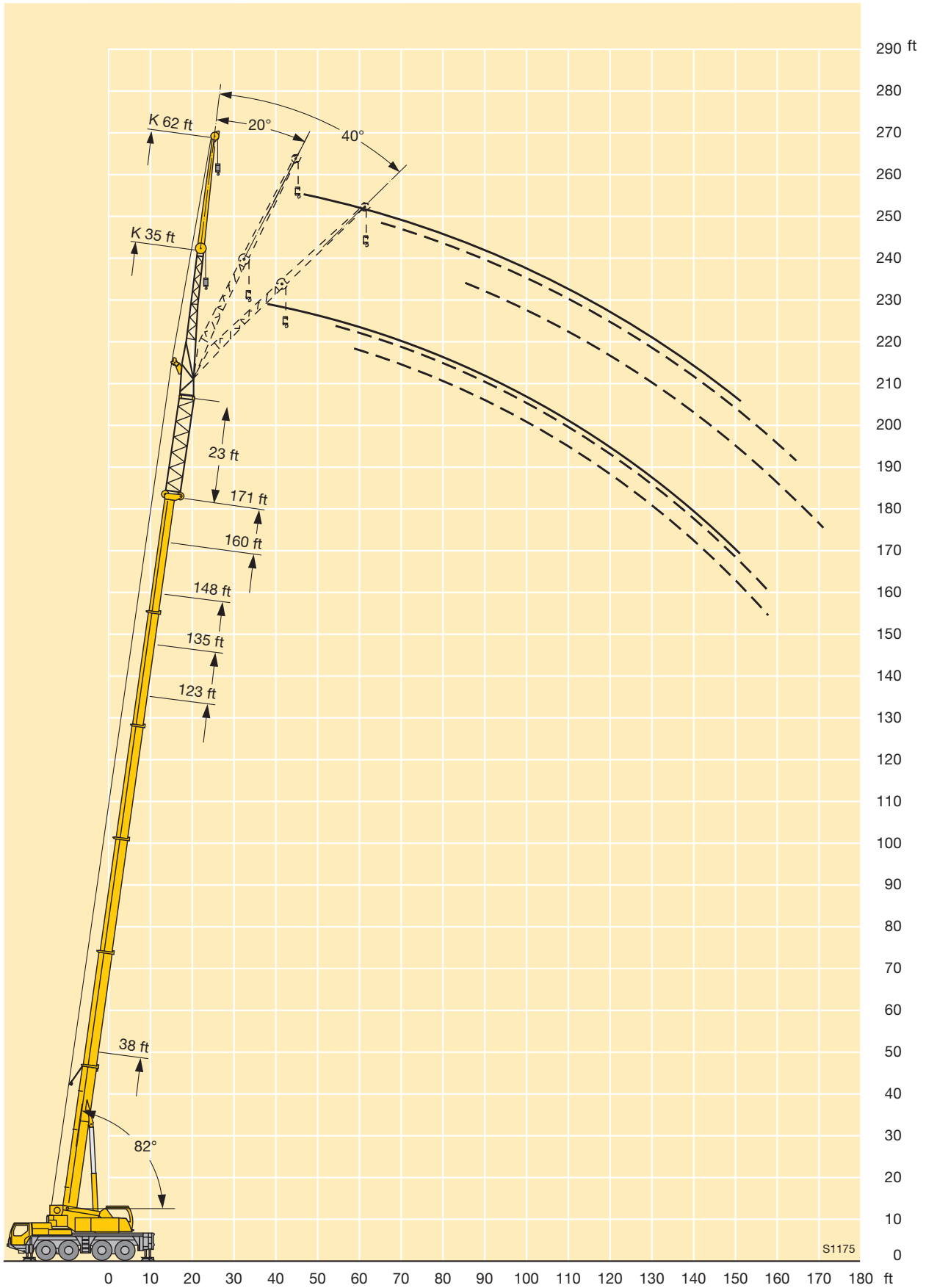

# Lifting capacities on the folding jib with boom extension

## Forces de levage à la fléchette pliante avec télescope rallongé



ft	38 ft + 46 ft			135 ft + 46 ft			148 ft + 46 ft			160 ft + 46 ft			171 ft + 46 ft			ft
	35 ft			35 ft			35 ft			35 ft			35 ft			
	0°	20°	40°	0°	20°	40°	0°	20°	40°	0°	20°	40°	0°	20°	40°	
16	9.9															16
17	9.8															17
18	9.7															18
20	9.4															20
22	9.2	8.9														22
24	8.9	8.8														24
26	8.7	8.8														26
28	8.5	8.5														28
30	8.2	8.3														30
32	8	8	7.7	10.1												32
34	7.8	7.8	7.6	10.1												34
36	7.6	7.6	7.5	9.9												36
38	7.3	7.4	7.4	9.8			9.3			7.8						38
40	7.1	7.2	7.3	9.7			9.2			7.8						40
45	6.6	6.7	6.8	9.3	8.9		8.9			7.8			6.3			45
50	6.2	6.2	6.3	9	8.6		8.6	8.1		7.8	7.7		6.2			50
55	5.8	5.8	5.9	8.7	8.2	7.7	8.3	8	7.4	7.7	7.6		6.1	6.1		55
60	5.5	5.5	5.5	8.4	7.9	7.6	8.1	7.7	7.4	7.6	7.3		6	6.1		60
65	5.1	5.1	5.2	8	7.6	7.3	7.8	7.4	7.1	7.4	7.1	6.8	5.9	5.9	5.8	65
70	4.8	4.8	4.9	7.7	7.3	7	7.5	7.1	6.9	7.2	6.8	6.6	5.7	5.6	5.6	70
75	4.6	4.6	4.6	7.4	7	6.8	7.2	6.9	6.6	6.9	6.6	6.4	5.5	5.4	5.4	75
80	4.3	4.3	4.4	7.1	6.8	6.5	7	6.6	6.4	6.7	6.4	6.2	5.3	5.2	5.2	80
85	4.1	4.1	4.1	6.8	6.5	6.3	6.7	6.4	6.2	6.5	6.2	6	5.1	5.1	5	85
90	3.9	3.9	3.9	6.6	6.2	6.1	6.5	6.2	6	6.3	6	5.8	4.9	4.9	4.9	90
95	3.7	3.7	3.7	6.3	6	5.9	6.3	6	5.8	6.1	5.8	5.7	4.7	4.7	4.7	95
100	3.5	3.5	3.5	6.1	5.8	5.7	6.1	5.8	5.6	5.9	5.6	5.5	4.6	4.5	4.5	100
105				5.9	5.6	5.5	5.9	5.6	5.4	5.7	5.4	5.3	4.4	4.3	4.3	105
110				5.7	5.4	5.3	5.7	5.4	5.2	5.6	5.3	5.1	4.3	4.2	4.2	110
115				5.5	5.2	5.1	5.5	5.2	5.1	5.4	5.2	5	4.1	4	4.1	115
120				5.3	5.1	5	5.3	5.1	5	5.2	5	4.9	4	3.9	3.9	120
125				5.1	4.9	4.8	5.2	4.9	4.8	4.8	4.9	4.8	3.9	3.8	3.8	125
130				5	4.8	4.7	5	4.8	4.7	4.2	4.7	4.6	3.7	3.7	3.7	130
135				4.8	4.6	4.6	4.6	4.7	4.6	3.7	4.3	4.5	3.3	3.6	3.6	135
140				4.6	4.5	4.5	4.1	4.5	4.5	3.1	3.7	4.1	2.8	3.3	3.4	140
145				4.4	4.4	4.3	3.6	4.1	4.3	2.7	3.2	3.6		2.9	3.3	145
150				3.9	4.2	4.2	3.2	3.6	3.9	2.2	2.7	3.1		2.5	2.8	150
155				3.5	3.8	4	2.7	3.2	3.4		2.3	2.6			2.4	155
160				3.1	3.4		2.3	2.7	3			2.1				160
165				2.7	3			2.3								165
170				2.3	2.6			1.9								170
175				1.9	2.2											175

TAB 140293 / 140295 / 140297



# Lifting capacities on the folding jib with boom extension

## Forces de levage à la fléchette pliante avec télescope rallongé



ft	38 ft + 46 ft			135 ft + 46 ft			148 ft + 46 ft			160 ft + 46 ft			171 ft + 46 ft			ft
	62 ft			62 ft			62 ft			62 ft			62 ft			
	0°	20°	40°	0°	20°	40°	0°	20°	40°	0°	20°	40°	0°	20°	40°	
22	6.9															22
24	6.8															24
26	6.7															26
28	6.5															28
30	6.4															30
32	6.3															32
34	6.2															34
36	6															36
38	5.9	6.1		7.1			6.7									38
40	5.8	6		7.1			6.7									40
45	5.4	5.7		6.9			6.5			5.3						45
50	5.1	5.3		6.7			6.3			5.3			4.5			50
55	4.8	5	5.1	6.5			6.2			5.2			4.3			55
60	4.5	4.7	5	6.3			6			5.1			4.1			60
65	4.2	4.4	4.7	6.1	5.8		5.8	5.6		5.1			4.1			65
70	4	4.2	4.4	5.9	5.6		5.7	5.5		5.1	4.9		4.1	4.2		70
75	3.8	4	4.1	5.7	5.4	5.2	5.5	5.3		5.1	4.9		4.1	4.1		75
80	3.6	3.7	3.9	5.5	5.2	5.1	5.3	5.1		5	4.9		4	4		80
85	3.4	3.5	3.7	5.2	5.1	5	5.1	4.9	4.8	4.9	4.7		3.9	3.8		85
90	3.2	3.3	3.5	5.1	4.9	4.8	5	4.8	4.7	4.7	4.6	4.5	3.7	3.7	3.7	90
95	3.1	3.2	3.3	4.9	4.7	4.6	4.8	4.6	4.5	4.6	4.5	4.4	3.6	3.6	3.6	95
100	2.9	3	3.1	4.7	4.5	4.5	4.7	4.5	4.4	4.4	4.3	4.3	3.5	3.5	3.5	100
105	2.8	2.9	3	4.5	4.4	4.3	4.5	4.3	4.3	4.3	4.2	4.1	3.3	3.4	3.4	105
110	2.6	2.7	2.8	4.4	4.2	4.2	4.4	4.2	4.1	4.2	4.1	4	3.2	3.3	3.3	110
115	2.5	2.6	2.7	4.2	4.1	4	4.2	4	4	4	3.9	3.9	3.1	3.2	3.2	115
120	2.4	2.4	2.6	4.1	4	3.9	4.1	3.9	3.9	3.9	3.8	3.8	3	3.1	3.1	120
125	2.3	2.3		3.9	3.8	3.8	3.9	3.8	3.8	3.8	3.7	3.7	2.9	3	3	125
130	2.2	2.3		3.8	3.7	3.7	3.8	3.7	3.7	3.7	3.6	3.6	2.8	2.9	2.9	130
135				3.7	3.6	3.6	3.7	3.6	3.6	3.6	3.5	3.5	2.7	2.8	2.8	135
140				3.6	3.5	3.5	3.6	3.5	3.5	3.5	3.4	3.4	2.6	2.7	2.8	140
145				3.5	3.4	3.4	3.5	3.4	3.4	2.9	3.3	3.3	2.5	2.6	2.7	145
150				3.4	3.3	3.3	3.3	3.3	3.3	2.4	3.2	3.2	2.1	2.5	2.6	150
155				3.3	3.2	3.2	2.9	3.2	3.2		2.9	3.2		2.4	2.5	155
160				3.1	3.1	3.1	2.5	3.1	3.1		2.5	3		2.2	2.4	160
165				2.9	3	3	2.2	2.9	3			2.7			2.3	165
170				2.5	2.9	2.9	1.8	2.5	2.9			2.3			2	170
175				2.2	2.7	2.9		2.1	2.6			1.9				175
180					2.4	2.7			2.2							180
185					2.1											185
190					1.8											190

TAB 140293 / 140295 / 140297

# Lifting heights Hauteurs de levage

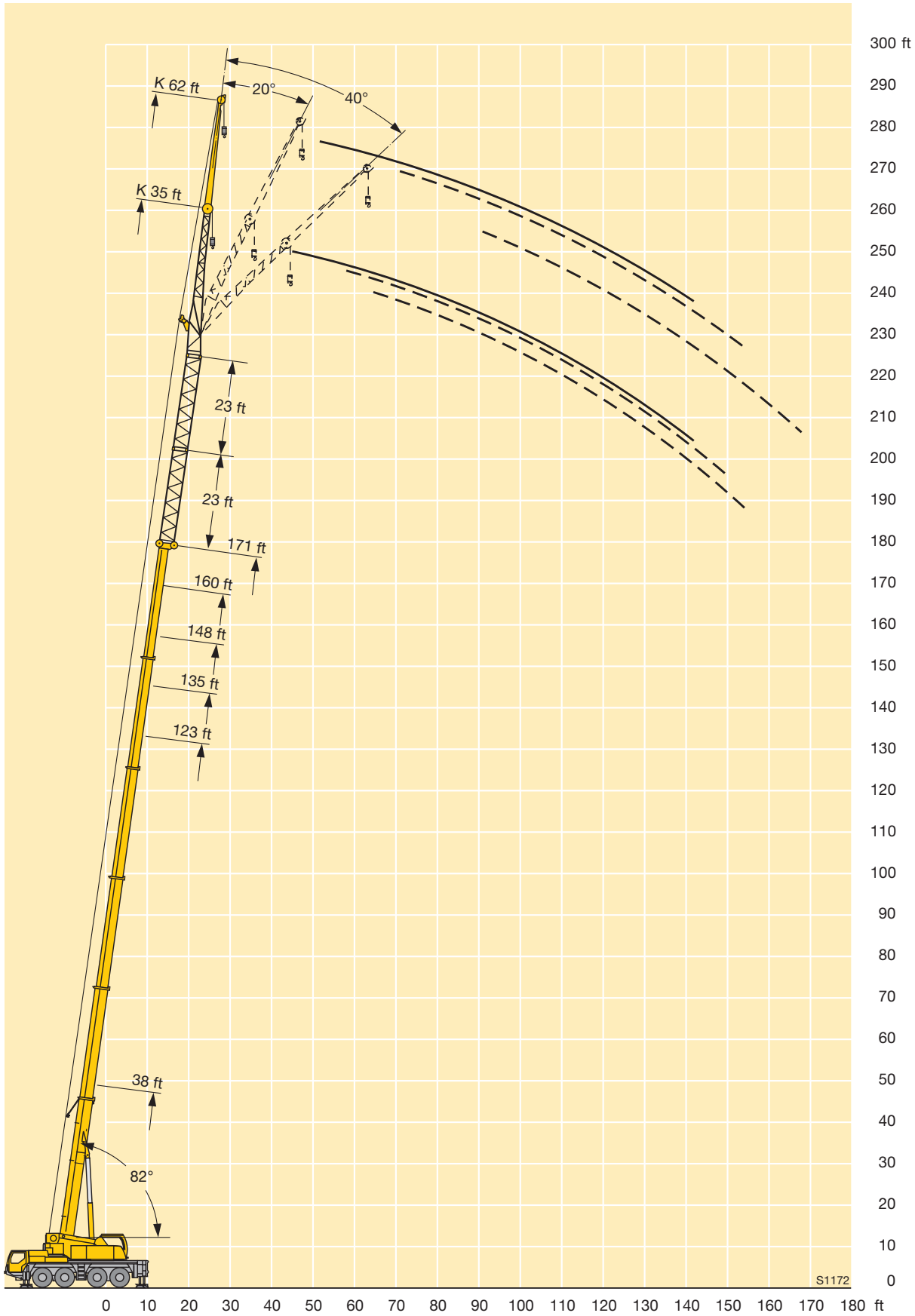

S1172

# Lifting capacities on the hydraulically variable folding jib with boom extension

## Capacités de levage à la fléchette pliante à variation hydraulique avec télescope rallongé



ft	38 ft + 23 ft			135 ft + 23 ft			148 ft + 23 ft			160 ft + 23 ft			171 ft + 23 ft			ft
	35 ft			35 ft			35 ft			35 ft			35 ft			
	0°	20°	40°	0°	20°	40°	0°	20°	40°	0°	20°	40°	0°	20°	40°	
13	13.5															13
14	13.3															14
15	13.1															15
16	12.9															16
17	12.7															17
18	12.5	12.1														18
20	12.1	12														20
22	11.7	11.7														22
24	11.4	11.4														24
26	11	11		14.4												26
28	10.6	10.6	10.1	14.2			13.2									28
30	10.3	10.3	10.1	14			13.2									30
32	10	10	9.9	13.8			13			12						32
34	9.7	9.7	9.6	13.5			12.8			12						34
36	9.4	9.4	9.3	13.3			12.6			11.8						36
38	9.1	9.1	9.1	13.1	12.1		12.4			11.7			9.7			38
40	8.8	8.8	8.8	12.9	12		12.3			11.5			9.7			40
45	8.2	8.2	8.1	12.4	11.5		11.9	11.1		11.1	10.5		9.3			45
50	7.6	7.7	7.6	12	11.1	10.1	11.5	10.7	9.9	10.8	10.3		8.9	8.5		50
55	7.1	7.2	7.2	11.5	10.6	9.9	11.1	10.4	9.7	10.5	10	9.2	8.6	8.3	7.9	55
60	6.7	6.8	6.8	11.1	10.2	9.6	10.7	10	9.4	10.2	9.6	9.1	8.3	8	7.9	60
65	6.3	6.4	6.4	10.6	9.8	9.2	10.3	9.7	9.1	9.8	9.3	8.8	8	7.8	7.6	65
70	5.9	6	6.1	10.2	9.4	8.9	10	9.3	8.8	9.5	9	8.6	7.7	7.5	7.3	70
75	5.6	5.6	5.7	9.8	9.1	8.6	9.6	9	8.5	9.2	8.8	8.3	7.4	7.2	7.1	75
80	5.2	5.3		9.4	8.8	8.3	9.3	8.7	8.3	9	8.5	8.1	7.2	7	6.8	80
85	4.7	5		9.1	8.5	8	9	8.4	8	8.7	8.2	7.8	6.9	6.7	6.6	85
90				8.7	8.2	7.8	8.7	8.2	7.8	8.4	8	7.6	6.7	6.4	6.3	90
95				8.4	8	7.6	8.4	7.9	7.6	8.2	7.8	7.4	6.5	6.2	6.1	95
100				8.1	7.7	7.4	8.1	7.7	7.4	7.9	7.6	7.2	6.2	6	5.9	100
105				7.8	7.5	7.2	7.9	7.5	7.2	7.7	7.4	7.1	6	5.8	5.7	105
110				7.6	7.3	7	7.6	7.3	7	7.1	7.2	6.9	5.9	5.6	5.6	110
115				7.3	7.1	6.8	7.3	7.1	6.8	6.4	6.9	6.8	5.7	5.5	5.4	115
120				7.1	6.9	6.7	6.7	6.9	6.7	5.7	6.4	6.6	5.3	5.3	5.3	120
125				6.8	6.7	6.5	6	6.6	6.5	5	5.7	6.2	4.8	5.2	5.1	125
130				6.2	6.5	6.4	5.4	6	6.2	4.4	5	5.5	4.2	4.7	5	130
135				5.6	6.1	6.2	4.9	5.4	5.7	3.9	4.4	4.8	3.6	4.2	4.6	135
140				5.1	5.5	5.8	4.3	4.8	5.1	3.4	3.9	4.2	3.1	3.6	4	140
145				4.6	5		3.8	4.3	4.5	2.9	3.4	3.7	2.6	3.1	3.5	145
150				4	4.4		3.4	3.8	4	2.4	2.9	3.1	2.1	2.6	2.9	150
155				3.6	3.9		2.9	3.3	3.5		2.4	2.6		2.2	2.5	155
160				3.1	3.4		2.5	2.9				2.2				160
165				2.7	2.9			2.4								165
170				2.3	2.5			1.9								170
175				1.9	2.1											175

TAB 140636 / 140638 / 140640

# Lifting capacities on the hydraulically variable folding jib with boom extension

## Capacités de levage à la fléchette pliante à variation hydraulique avec télescope rallongé



ft	38 ft + 23 ft			135 ft + 23 ft			148 ft + 23 ft			160 ft + 23 ft			171 ft + 23 ft			ft
	62 ft			62 ft			62 ft			62 ft			62 ft			
	0°	20°	40°	0°	20°	40°	0°	20°	40°	0°	20°	40°	0°	20°	40°	
18	9															18
20	9															20
22	8.9															22
24	8.7															24
26	8.5															26
28	8.4			9.3												28
30	8.2			9.3												30
32	8	7.5		9.2			8.8									32
34	7.8	7.5		9.2			8.7									34
36	7.6	7.4		9.2			8.7									36
38	7.4	7.4		9.2			8.7			8.2						38
40	7.2	7.3		9.1			8.7			8.2						40
45	6.8	6.9		8.9			8.5			8.1			6.8			45
50	6.4	6.5	6.3	8.7			8.3			7.9			6.6			50
55	6.1	6.1	6.2	8.4	7.5		8.1	7.4		7.7			6.4			55
60	5.7	5.8	6	8.2	7.5		7.9	7.4		7.5			6.2			60
65	5.4	5.5	5.6	7.9	7.3		7.7	7.2		7.3	6.9		6	5.8		65
70	5.1	5.2	5.4	7.6	7.1	6.3	7.4	7		7.1	6.7		5.8	5.7		70
75	4.9	5	5.1	7.4	6.8	6.3	7.2	6.7	6.3	6.9	6.5	5.9	5.7	5.5		75
80	4.7	4.7	4.8	7.2	6.6	6.3	7	6.5	6.2	6.7	6.3	5.9	5.5	5.3		80
85	4.5	4.5	4.6	6.9	6.4	6.1	6.8	6.3	6.1	6.5	6.1	5.9	5.3	5.2	5.1	85
90	4.3	4.3	4.4	6.7	6.2	5.9	6.6	6.1	5.9	6.4	6	5.7	5.1	5	4.9	90
95	4	4.1	4.3	6.5	6	5.8	6.4	6	5.7	6.2	5.8	5.6	4.9	4.8	4.8	95
100	3.9	4	4.1	6.2	5.8	5.6	6.2	5.8	5.6	6	5.7	5.5	4.8	4.7	4.7	100
105	3.7	3.8		6	5.6	5.5	6	5.6	5.4	5.9	5.5	5.3	4.6	4.5	4.6	105
110	3.5	3.6		5.9	5.5	5.3	5.8	5.5	5.3	5.7	5.4	5.2	4.5	4.4	4.4	110
115				5.7	5.3	5.2	5.7	5.3	5.2	5.6	5.2	5.1	4.3	4.3	4.3	115
120				5.5	5.2	5.1	5.5	5.2	5	5.4	5.1	5	4.2	4.1	4.2	120
125				5.4	5.1	4.9	5.4	5.1	4.9	5.3	5	4.9	4.1	4	4.1	125
130				5.2	4.9	4.8	5.2	4.9	4.8	4.8	4.9	4.8	4	3.9	4	130
135				5.1	4.8	4.7	5	4.8	4.7	4.2	4.8	4.7	3.8	3.8	3.9	135
140				4.9	4.7	4.6	4.7	4.7	4.6	3.7	4.6	4.6	3.4	3.7	3.8	140
145				4.8	4.6	4.5	4.2	4.6	4.5	3.2	4.2	4.5	2.9	3.6	3.7	145
150				4.4	4.5	4.4	3.7	4.5	4.5	2.8	3.7	4.3	2.5	3.4	3.6	150
155				4	4.4	4.4	3.3	4.1	4.4	2.4	3.2	3.9	2.1	3	3.4	155
160				3.6	4.2	4.3	2.9	3.6	4.1		2.8	3.4		2.5	3.1	160
165				3.2	3.8	4.2	2.5	3.2	3.6		2.3	2.9			2.7	165
170				2.8	3.4	3.7	2.2	2.8	3.2		1.9	2.4			2.2	170
175				2.5	3		1.8	2.4	2.7			2				175
180				2.1	2.6			2	2.3							180
185					2.2											185
190					1.8											190

TAB 140636 / 140638 / 140640

# Lifting heights Hauteurs de levage

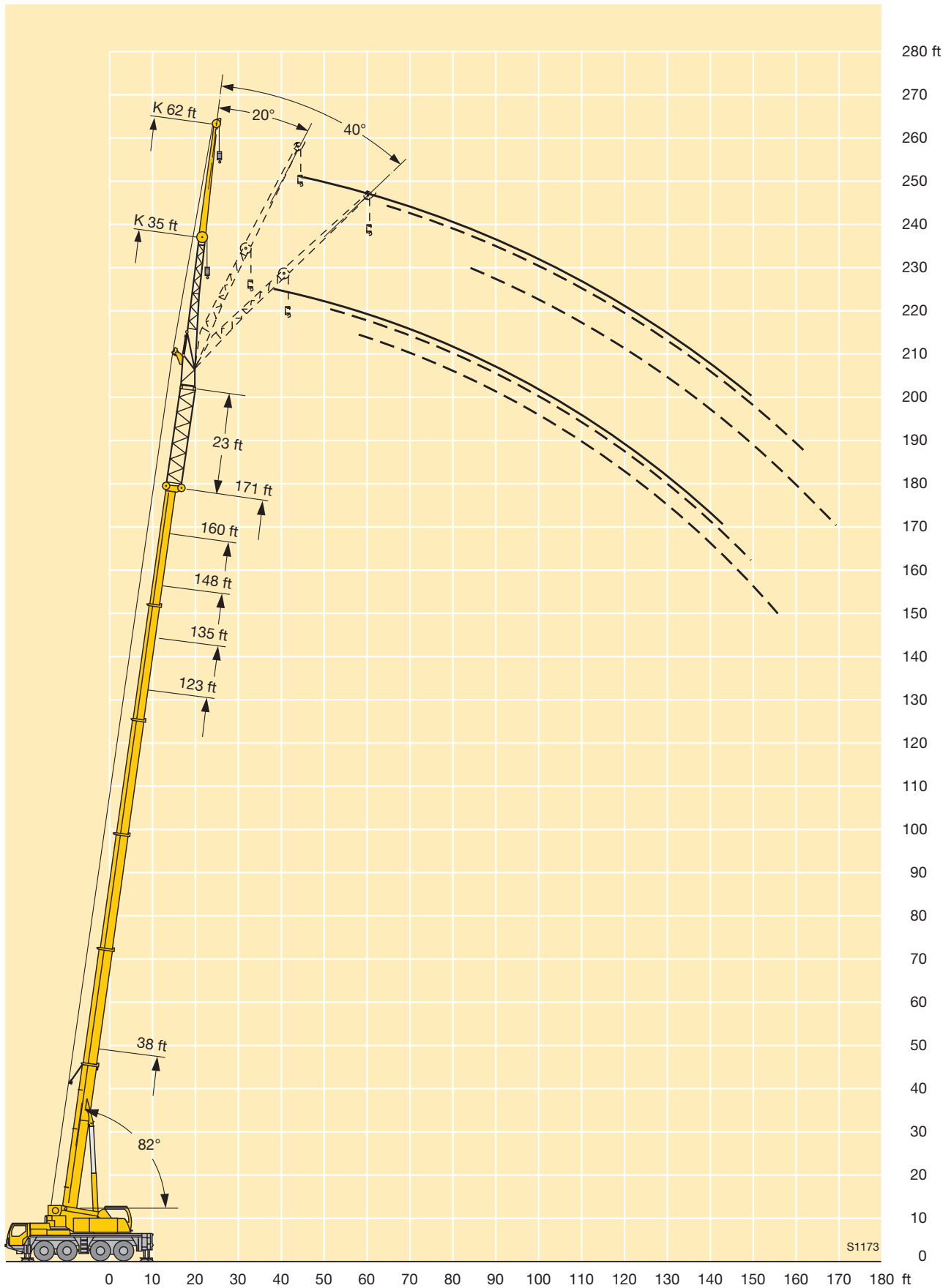

# Lifting capacities on the hydraulically variable folding jib with boom extension

## Capacités de levage à la fléchette pliante à variation hydraulique avec télescope rallongé



ft	38 ft + 46 ft			135 ft + 46 ft			148 ft + 46 ft			160 ft + 46 ft			171 ft + 46 ft			ft
	35 ft			35 ft			35 ft			35 ft			35 ft			
	0°	20°	40°	0°	20°	40°	0°	20°	40°	0°	20°	40°	0°	20°	40°	
16	9.7															16
17	9.6															17
18	9.5															18
20	9.2															20
22	9	8.7														22
24	8.8	8.7														24
26	8.5	8.7														26
28	8.3	8.4														28
30	8.1	8.2														30
32	7.8	7.9	7.5	10												32
34	7.6	7.7	7.5	9.9												34
36	7.4	7.5	7.4	9.8												36
38	7.2	7.2	7.3	9.6			9.2			7.5						38
40	7	7	7.2	9.5			9.1			7.5						40
45	6.5	6.5	6.6	9.1	8.7		8.8			7.5			6.1			45
50	6	6.1	6.2	8.8	8.4		8.5	8		7.5	7.5		5.9			50
55	5.7	5.7	5.8	8.5	8.1	7.5	8.2	7.8	7.3	7.5	7.4		5.8	6		55
60	5.3	5.3	5.4	8.2	7.8	7.5	7.9	7.5	7.3	7.4	7.2		5.8	5.9		60
65	5	5	5	7.8	7.4	7.2	7.6	7.2	7	7.2	6.9	6.7	5.8	5.7	5.6	65
70	4.7	4.7	4.7	7.5	7.1	6.9	7.3	7	6.7	7	6.7	6.5	5.6	5.5	5.5	70
75	4.4	4.5	4.5	7.2	6.9	6.6	7	6.7	6.5	6.8	6.5	6.3	5.4	5.3	5.3	75
80	4.2	4.2	4.2	6.9	6.6	6.4	6.8	6.5	6.3	6.5	6.3	6.1	5.1	5.1	5.1	80
85	4	4	4	6.7	6.3	6.1	6.5	6.2	6.1	6.3	6	5.9	4.9	4.9	4.9	85
90	3.7	3.7	3.8	6.4	6.1	5.9	6.3	6	5.8	6.1	5.8	5.7	4.7	4.7	4.7	90
95	3.5	3.5	3.5	6.2	5.9	5.7	6.1	5.8	5.6	5.9	5.6	5.5	4.6	4.5	4.5	95
100	3.3	3.4	3.3	6	5.7	5.5	5.9	5.6	5.5	5.7	5.5	5.3	4.4	4.4	4.4	100
105				5.7	5.5	5.3	5.7	5.4	5.3	5.6	5.3	5.2	4.3	4.2	4.2	105
110				5.5	5.3	5.1	5.5	5.2	5.1	5.4	5.1	5.1	4.1	4	4.1	110
115				5.3	5.1	5	5.3	5.1	5	5.2	5	4.9	4	3.9	3.9	115
120				5.1	5	4.8	5.2	5	4.8	5	4.8	4.8	3.8	3.8	3.8	120
125				5	4.8	4.7	5	4.8	4.7	4.5	4.7	4.6	3.7	3.6	3.7	125
130				4.8	4.6	4.6	4.8	4.6	4.6	3.9	4.5	4.5	3.5	3.5	3.5	130
135				4.7	4.5	4.4	4.3	4.5	4.5	3.4	4	4.3	3.1	3.4	3.4	135
140				4.4	4.4	4.3	3.8	4.3	4.3	2.9	3.4	3.9	2.6	3.1	3.3	140
145				4.1	4.2	4.2	3.3	3.8	4.1		2.9	3.3		2.7	3.1	145
150				3.6	4	4.1	2.9	3.3	3.6		2.5	2.8		2.2	2.6	150
155				3.2	3.6	3.8	2.4	2.9	3.1			2.3			2.1	155
160				2.8	3.1			2.4	2.7							160
165				2.4	2.7											165
170				2	2.3											170
175					1.9											175

TAB 140642 / 140644 / 140646

# Lifting capacities on the hydraulically variable folding jib with boom extension

## Capacités de levage à la fléchette pliante à variation hydraulique avec télescope rallongé



ft	38 ft + 46 ft			135 ft + 46 ft			148 ft + 46 ft			160 ft + 46 ft			171 ft + 46 ft			ft
	62 ft			62 ft			62 ft			62 ft			62 ft			
	0°	20°	40°	0°	20°	40°	0°	20°	40°	0°	20°	40°	0°	20°	40°	
22	6.8															22
24	6.7															24
26	6.6															26
28	6.4															28
30	6.3															30
32	6.2															32
34	6															34
36	5.9															36
38	5.8	5.7		7			6.6									38
40	5.6	5.7		7			6.6									40
45	5.3	5.6		6.8			6.4			5.1						45
50	5	5.3		6.6			6.2			5.1			4.1			50
55	4.7	4.9	5.1	6.3			6			5			4			55
60	4.4	4.6	4.9	6.1			5.9			4.9			3.9			60
65	4.2	4.4	4.6	5.9	5.7		5.7	5.5		4.9			3.9			65
70	3.9	4.1	4.3	5.7	5.6		5.5	5.4		4.9	4.8		3.9	4.1		70
75	3.7	3.9	4.1	5.5	5.3	5.1	5.4	5.2		4.9	4.8		3.9	4		75
80	3.5	3.6	3.8	5.3	5.1	5.1	5.2	5		4.8	4.8		3.9	3.9		80
85	3.3	3.4	3.6	5.1	5	4.9	5	4.8	4.8	4.8	4.6		3.8	3.7		85
90	3.1	3.2	3.4	4.9	4.8	4.7	4.8	4.7	4.6	4.6	4.5	4.4	3.6	3.6	3.6	90
95	3	3.1	3.2	4.8	4.6	4.5	4.7	4.5	4.4	4.5	4.3	4.3	3.5	3.5	3.5	95
100	2.8	2.9	3	4.6	4.4	4.4	4.5	4.3	4.3	4.3	4.2	4.2	3.3	3.4	3.4	100
105	2.7	2.8	2.9	4.4	4.3	4.2	4.3	4.2	4.1	4.2	4.1	4	3.2	3.2	3.3	105
110	2.5	2.6	2.7	4.3	4.1	4.1	4.2	4.1	4	4.1	3.9	3.9	3.1	3.2	3.2	110
115	2.4	2.4	2.6	4.1	4	3.9	4.1	3.9	3.9	3.9	3.8	3.8	3	3.1	3.1	115
120	2.3	2.3	2.4	4	3.9	3.8	3.9	3.8	3.8	3.8	3.7	3.7	2.8	2.9	3	120
125	2.2	2.2		3.9	3.7	3.7	3.8	3.7	3.7	3.7	3.6	3.6	2.7	2.8	2.9	125
130	2.1	2.1		3.7	3.6	3.6	3.7	3.6	3.6	3.6	3.5	3.5	2.6	2.7	2.8	130
135				3.6	3.5	3.5	3.6	3.5	3.5	3.5	3.4	3.4	2.6	2.7	2.8	135
140				3.5	3.4	3.4	3.5	3.4	3.4	3.2	3.3	3.3	2.5	2.6	2.7	140
145				3.4	3.3	3.3	3.3	3.3	3.3	2.7	3.2	3.2		2.4	2.6	145
150				3.2	3.2	3.2	3.1	3.2	3.2	2.2	3.1	3.1		2.4	2.5	150
155				3.1	3.1	3.1	2.7	3.1	3.1		2.7	3.1		2.3	2.4	155
160				2.9	3	3	2.3	2.9	3		2.3	2.9			2.3	160
165				2.6	2.9	2.9		2.7	2.9			2.5			2.1	165
170				2.3	2.8	2.8		2.3	2.8			2.1			1.8	170
175				2	2.5	2.8		1.9	2.4							175
180					2.2	2.5			2							180

TAB 140642 / 140644 / 140646

# Lifting heights Hauteurs de levage

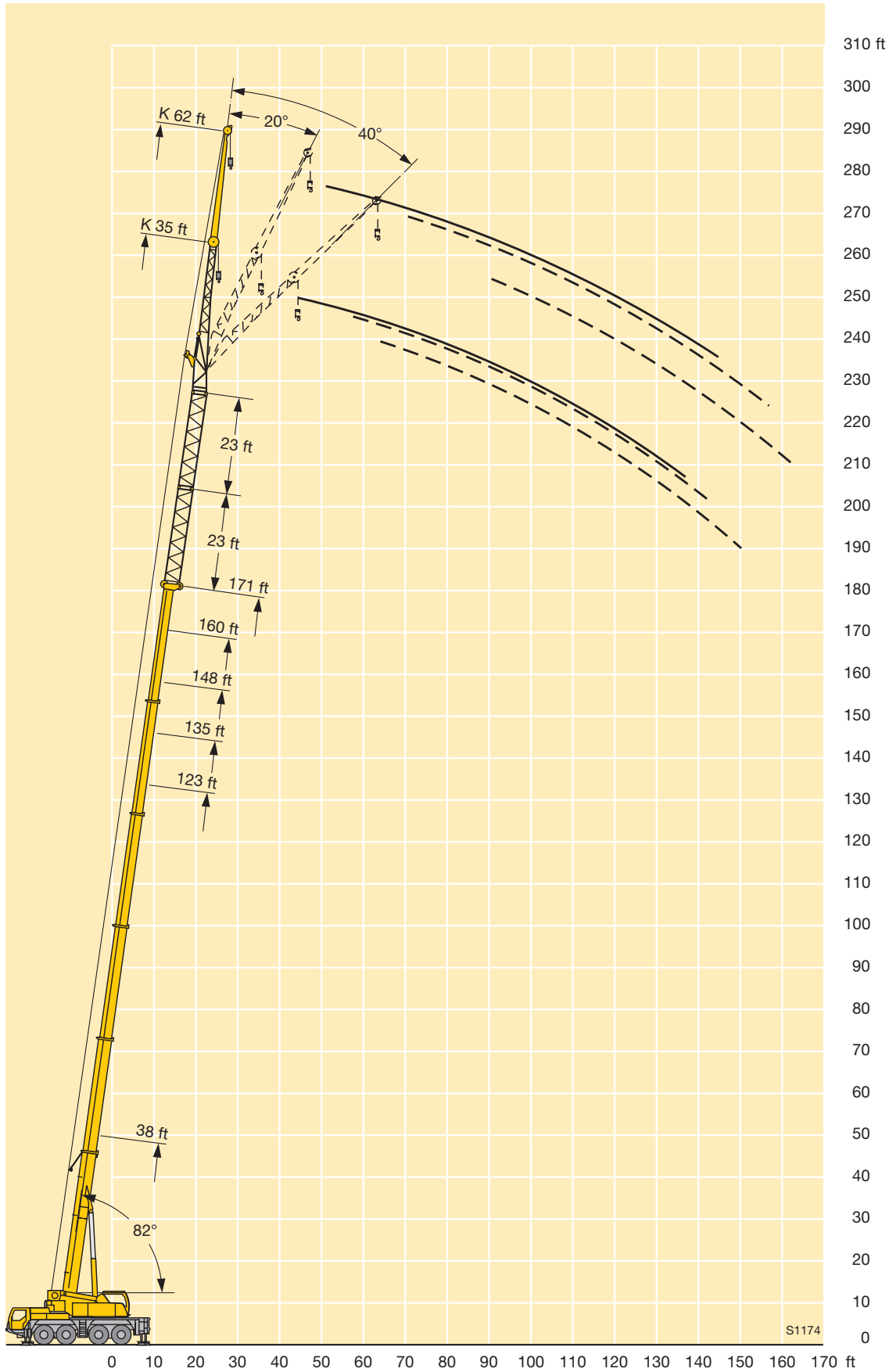



# Lifting capacities on the erection jib

## Forces de levage à la fléchette de montage



ft	38 ft	50 ft	62 ft	74 ft	87 ft	99 ft	111 ft	123 ft	135 ft	148 ft	160 ft	171 ft	ft
9	76.5												9
10	76.5												10
11	76.5	76.5	76.5										11
12	76.5	76.5	76.5										12
13	76.5	76.5	76.5	76.5									13
14	76.5	76.5	76.5	76.5	76.5								14
15	76.5	76.5	76.5	76.5	76.5								15
16	76.5	76.5	76.5	76.5	76.5	76.5							16
17	76.5	76.5	76.5	76.5	76.5	76							17
18	76.5	76.5	76.5	76.5	76.5	76	60.5						18
20	76.5	76.5	76.5	76.5	76.5	75	60.5						20
22	76.5	76.5	76.5	76.5	76.5	72	59.1	52.5					22
24	76	76.5	76.5	76.5	76	69.5	57.7	51.8					24
26	76	76.5	76.5	76.5	75.5	66.5	56.4	50.5	42.2				26
28	74	76.5	76	73.5	72	63.5	55	49.2	41.4	34.3			28
30	72.5	75	74	69.5	67.5	60.5	53.5	47.8	40.6	34.1			30
32	69.5	70.5	68	64	62	57.5	51.8	46	39.8	33.6	26.9		32
34		66	63	59.5	57.8	54.6	49.9	44.4	38.8	33.1	26.7		34
36		61.5	58.5	55.4	53.9	51.7	47.9	42.8	37.6	32.6	26.3		36
38		57	54.2	51.3	50	48.8	45.9	41.3	36.4	32.1	25.8	20.6	38
40		52.9	50.3	47.6	46.7	46	43.8	39.7	35.2	31.6	25.4	20.5	40
45		45	42.9	40.5	41.8	39.8	38.1	35.6	32.5	29.9	24.3	19.6	45
50			37	36.3	36.7	34.7	33.2	32	29.8	28.2	23.3	18.7	50
55			32	33	32.3	30.4	29.6	28.5	27.3	26.1	22.4	17.8	55
60				29.9	28.6	27	26.8	25.2	25	23.7	21.5	17	60
65				26.3	25.5	25.1	24	23.1	22.4	21.4	20.7	16.3	65
70				23.4	22.8	22.9	22	21.1	20.3	19.9	18.9	15.7	70
75					20.3	20.7	20	19.3	18.6	18.3	17	15.1	75
80					18.2	18.5	18	17.7	17.3	16.5	15.3	14.4	80
85					16.3	16.6	16.5	16.1	15.7	14.9	13.7	13.4	85
90						15	15.1	14.9	14.1	13.4	12.4	12.2	90
95						14	13.8	13.5	12.7	12.1	11.2	11	95
100							12.6	12.3	11.6	10.9	10.1	9.9	100
105								11.2	10.5	9.9	9.1	8.9	105
110								10.4	9.6	9	8.2	8	110
115								9.5	8.8	8.2	7.3	7.2	115
120									8.1	7.5	6.6	6.5	120
125									7.4	6.8	5.9	5.8	125
130									6.7	6.2	5.3	5.2	130
135										5.5	4.7	4.6	135
140										4.9	4.1	4	140
145											3.5	3.5	145
150											3	2.9	150
155											2.5	2.4	155

TAB 140536

# Lifting heights Hauteurs de levage

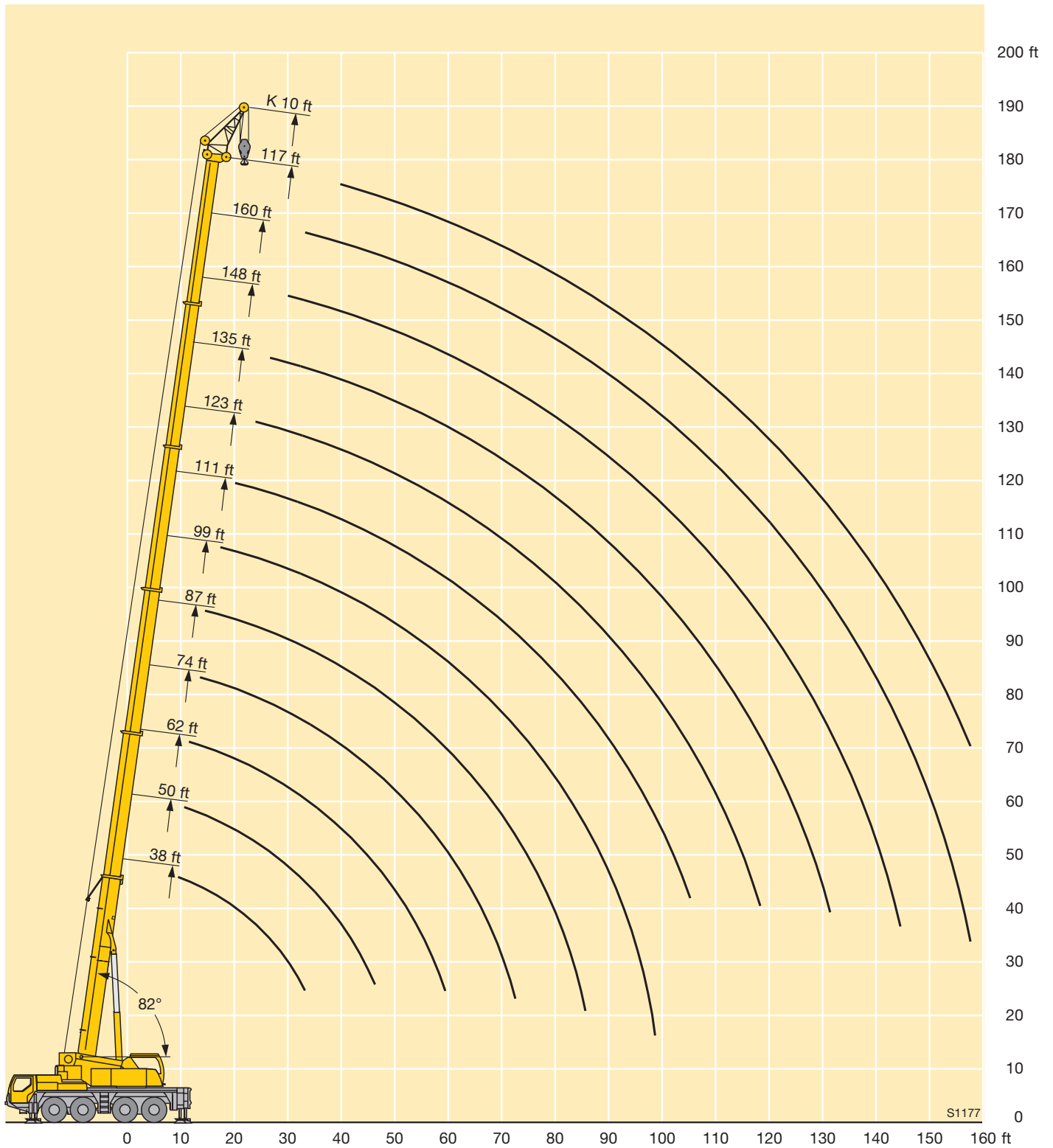

# Dimensions Encombrement

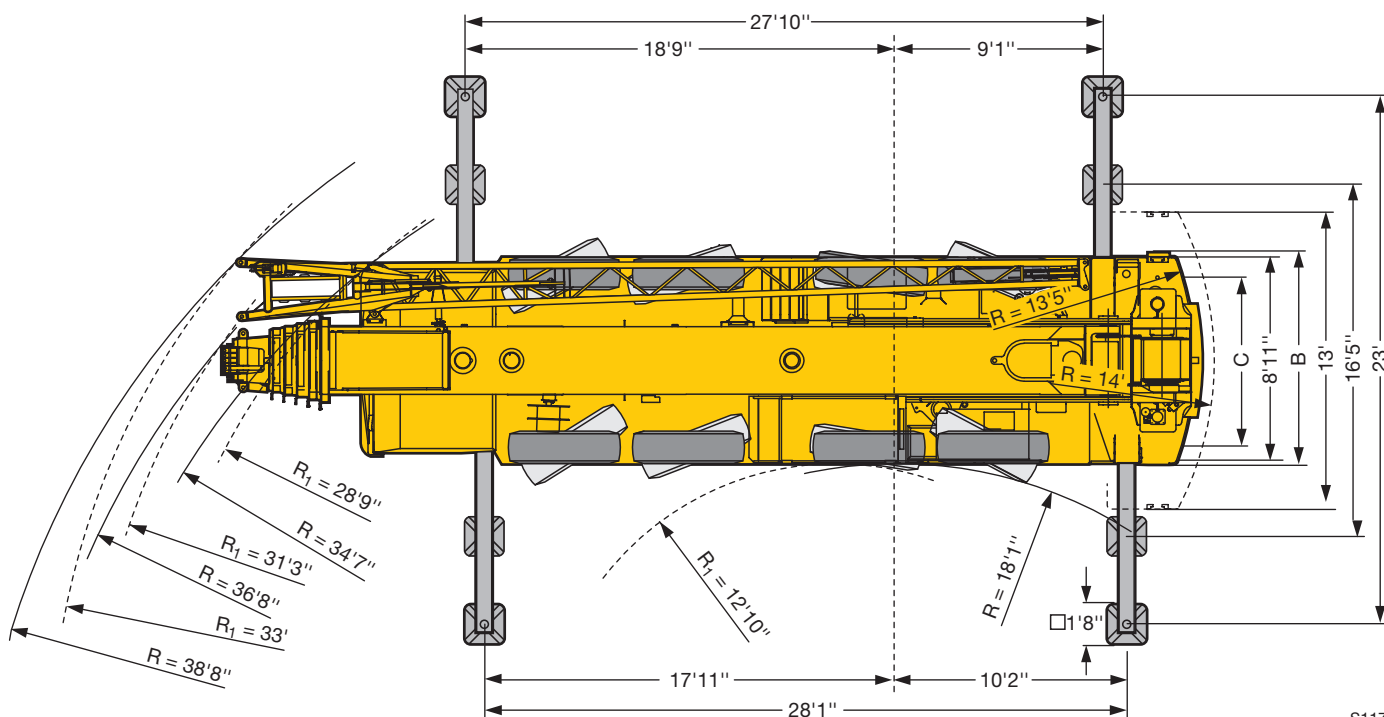
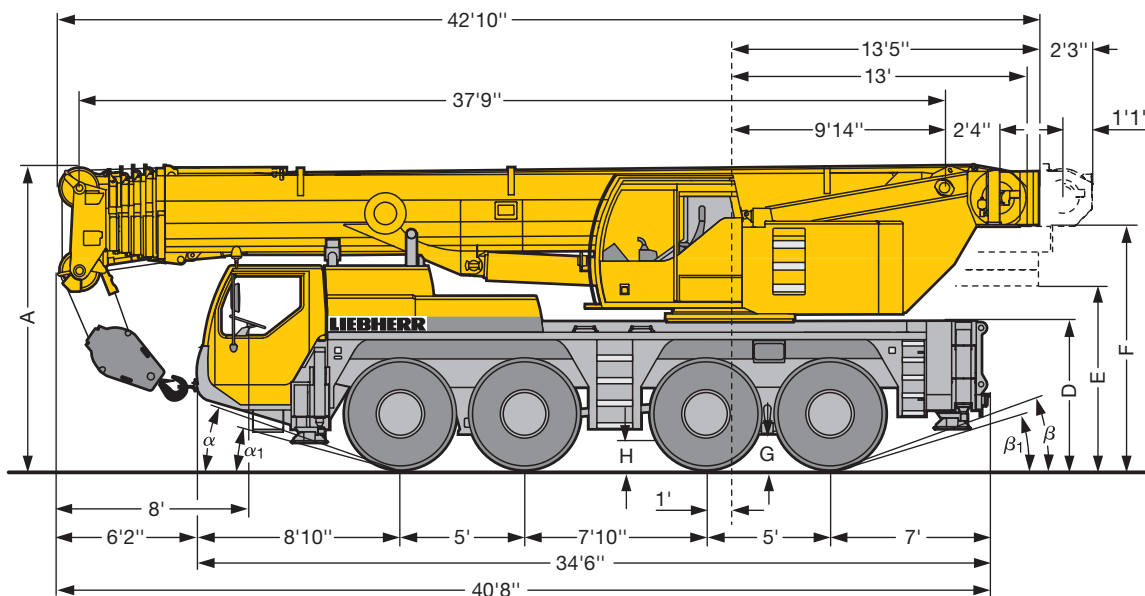

S1170

R<sub>1</sub> = All-wheel steering / Direction toutes roues

	Dimensions / Encombrement													
	A	A	B	C	D	E	F	G	H	α	α <sub>1</sub>	β	β <sub>1</sub>	
16.00 R 25	13'1"	12'8" 0'6" *	9'	7'	6'4"	7'10"	10'6"	1'5"	1'6"	20°	15°	20°	17°	
20.5 R 25	13'1"	12'8"	9'9"	7'11"	6'4"	7'10"	10'6"	1'5"	1'6"	20°	15°	20°	17°	

\* lowered / abaissé

## Weights Poids



Axle Essieu lbs	1	2	3	4	Total weight (lbs) Poids total lbs
	26400	26400	26400	26400	105600 <sup>1)</sup>

<sup>1)</sup> with 1760 lbs counterweight and folding jib / avec contrepoids 1760 lbs et fléchette pliante



Load (kips) Forces de levage kips	No. of sheaves Poulies	No. of lines Brins	Weight lbs Poids lbs
238	7	14	2600
198	5	11	1540
130	3	7	1100
57	1	3	990
19.4	–	1	550

## Working speeds Vitesses



		1	2	3	4	5	6	7	8	9	10	11	12	R 1	R 2	
16.00 R 25 20.5 R 25	mph	3.5	4.5	5.8	7.5	9.4	12.2	16	20.6	26.5	34.1	43.2	50	3.8	4.8	49 %



Drive Mécanismes	infinitely variable en continu	Rope diameter / Rope length Diamètre du câble / Longueur du câble	Max. single line pull Effort au brin maxi.
	0 – 360 ft/min single line ft/min au brin simple	0'8" / 656'	19400 lbs
	0 – 360 ft/min single line ft/min au brin simple	0'8" / 656'	19400 lbs
	0 – 1.8 rpm		
	approx. 60 seconds to reach 82° boom angle env. 60 s jusqu'à 82°		
	approx. 360 seconds for boom extension from 38 ft – 171 ft env. 360 s pour passer de 38 ft – 171 ft		

## Equipment Equipment

### Crane carrier

<b>Frame</b>	Self-manufactured, weight-optimized and torsion resistant box-type design of high-tensile structural steel.
<b>Outriggers</b>	4-point supporting system, hydraulically telescopic into horizontal and vertical direction. Automatic levelling of crane. Electronic inclination indicator.
<b>Engine</b>	6-cylinder Diesel, make Liebherr, type D 846 TI A5, watercooled, output 338 kW (460 h.p.) at 1900 min <sup>-1</sup> acc. to ECE-R 24.03 and 2001/27/EG (Euro 3), max. torque 1546 lbs/ft at 900 – 1300 min <sup>-1</sup> . Fuel reservoir: 106 gallons.
<b>Transmission</b>	ZF 12-speed gear box with automatic control system AS-TRONIC. ZF-intarder fitted directly to the gear. Two-stage transfer case with lockable transfer differential.
<b>Axles</b>	Welded design, made of high-tensile fine grained steel. All Axles steerable. Axles 2, 3 and 4 are planetary axles with differential locks.
<b>Suspension</b>	All axles are mounted on hydropneumatic suspension and are lockable hydraulically.
<b>Tyres</b>	8 tyres, size: 16.00 R 25.
<b>Steering</b>	ZF-servocom power steering, dual circuit system, with hydraulic servo system and auxiliary pump circuit. At road travel, the 4 <sup>th</sup> axle is steered electrohydraulically, and fixed for straight travel from 15,5 mph onwards. Steering acc. to EG directive 70/311/EWG.
<b>Brakes</b>	Service brake: Dual circuit, all-wheel servo-air brake. Parking brake: Spring brake actuator, acting on the wheels of the 1 <sup>st</sup> , 2 <sup>nd</sup> and 3 <sup>rd</sup> axle. Sustained-action brakes: Engine brake as exhaust retarder with Liebherr additional brake system ZBS. Intarder on gear. ABV in conjunction with ASR. Brakes acc. to EG directives 71/320 EWG.
<b>Driver's cab</b>	Spacious, steel made, corrosion resistant cab, cataphoretic dip-primed, on resilient suspension with hydraulic shock absorbers, sound and heat absorbing internal panelling acc. to EG directive, safety glazing, operating and control instruments, comfortably equipped.
<b>Electrical system</b>	Modern data bus technique, 24 Volt DC, 2 batteries of 170 Ah each, lighting according to traffic regulations.

### Crane superstructure

<b>Frame</b>	Self-manufactured, cataphoretic dip-primed weight-optimized and torsion resistant welded design of high-tensile structural steel; linked by a triple-row roller slewing ring to the carrier for continuous rotation.
<b>Crane engine</b>	4-cylinder Diesel, make Liebherr, type D 924 TI-E A4, watercooled, output 149 kW (202 h.p.) at 1800 min <sup>-1</sup> acc. to EPA/CARB and to directive 97/68 EG, stage 2, max. torque 646 lbs/ft at 1150 min <sup>-1</sup> , fuel reservoir: 74 gallons.
<b>Crane drive</b>	Diesel-hydraulic, with 2 axial piston variable displacement pumps, with servo-control and capacity control, 1 double gear pump, open controlled oil circuits. Compact hydraulic drive flanged to the Diesel engine. Drive assembly completely enclosed for noise abatement.
<b>Control</b>	Electric "Load Sensing" control, simultaneous operation of 4 working motions, 2 self-centering hand control levers (joy-stick type).
<b>Hoist gear</b>	Axial piston fixed displacement motor, Liebherr hoist drum with integrated planetary gear and spring-loaded static brake.
<b>Luffing gear</b>	1 differential ram with safety check valves.
<b>Slewing gear</b>	Axial piston fixed displacement motor, planetary gear, spring-loaded static brake.
<b>Crane cab</b>	All-steel construction, entirely galvanized, powder coated, with safety glazing, operating and control instruments, comfortably equipped, cab tiltable backwards.
<b>Safety devices</b>	LICCON safe load indicator, test system hoist limit switch, safety valves to prevent pipe and hose ruptures.
<b>Telescopic boom</b>	Buckling and torsion resistant design of high-tensile structural steel, oviform boom profile, 1 base section and 5 telescopic sections. All telescopic sections hydraulically extendable independent of one another. Rapid-cycle telescoping system "Telematik". Boom length: 38 ft – 171 ft.
<b>Counterweight</b>	26400 lbs basic counterweight.
<b>Electrical system</b>	Modern data bus technique, 24 Volt DC, 2 batteries of 170 Ah each.

### Additional equipment

<b>Swing-away jib</b>	35 ft – 62 ft long, mountable to the telescopic boom at 0°, 20° or 40°. Hydraulic ram for operating the swing-away jib from 0° – 40° (option).
<b>Telescopic boom extension</b>	23 ft – 46 ft long lattice section, thus 23 ft – 46 ft higher pinning point for swing-away jib.
<b>2<sup>nd</sup> hoist gear</b>	For two-hook operation or for operation with swing-away jib if the hoist rope shall remain reeved.
<b>Additional counterweight</b>	22050 lbs for a total counterweight of 48500 lbs.
<b>Drive 8 x 8</b>	Additional drive of the 1 <sup>st</sup> axle.

Other items of equipment available on request.

## Châssis porteur

<b>Cadre</b>	Construction en caisse résistante à la torsion et optimisée en poids réalisée par Liebherr en acier de construction à grain fin très rigide.
<b>Calage</b>	Dispositif de calage horizontal et vertical en 4 points, entièrement déployable hydrauliquement. Nivellement automatique du calage. Indicateurs électroniques d'inclinaison.
<b>Moteur</b>	Moteur Diesel, 6 cylindres, fabriqué par Liebherr, type D 846 TI A5, refroidi à l'eau, puissance 338 kW (460 ch) à 1900 min <sup>-1</sup> suivant ECE-R 24.03 et 2001/27/EG (Euro 3), couple maxi 1546 lbs/ft à 900 – 1300 min <sup>-1</sup> . Réservoir de carburant: 106 gallons.
<b>Boîte de vitesse</b>	Boîte de vitesses ZF à 12 rapports, mécanisme automatisé à commande AS-TRONIC. Ralentisseur hydrodynamique ZF directement accouplé à la boîte. Boîte de transfert à 2 étages avec blocage de différentiel.
<b>Essieux</b>	Construction soudée en acier à haute résistance fins grains. Tous les essieux directeurs. Essieux 2, 3 et 4 planétaires avec blocage différentiel.
<b>Suspension</b>	Suspension hydropneumatique sur tous les essieux. Chaque essieu peut être bloqué hydrauliquement.
<b>Pneumatiques</b>	8 pneus de taille: 16.00 R 25.
<b>Direction</b>	Direction hydraulique ZF-servocom, à deux circuits, assistée hydrauliquement, avec pompe auxiliaire entraînée par essieu. Lors de déplacement routier, le 4 <sup>ème</sup> essieu est dirigé électrohydrauliquement, et fixé en marche directe à partir de 15,5 mph. Direction conforme aux directives européennes 70/311/CE.
<b>Freins</b>	Freins de service: servofrein à air comprimé, à 2 circuits. Frein à main: ressort accumulé agissant sur les roues des essieux 1, 2 et 3. Freins continus: frein moteur par clapet sur échappement avec système de ralentissement Liebherr ZBS. Ralentisseur hydrodynamique accouplé à la boîte de vitesses. ABV avec contrôle ASR. Freins conformes aux directives européennes 71/320 CE.
<b>Cabine du conducteur</b>	Cabine spacieuse en tôle d'acier, traitement anticorrosion par bain de cataphorèse, avec suspension élastique et amortisseurs hydrauliques, revêtement intérieur avec isolation phonique et thermique selon les directives européennes, glaces de sécurité, appareils de commande et de contrôle, équipement confortable.
<b>Installation électrique</b>	Technique moderne de transmission de données par BUS de données, courant continu 24 Volts, 2 batteries de 170 Ah chacune, éclairage conforme au code de la route.

## Partie tournante

<b>Cadre</b>	Construction soudée résistante à la torsion et optimisée en poids réalisée par Liebherr en acier de construction à grain fin très rigide. Couronne d'orientation à rouleaux à 3 rangées permettant une rotation illimitée sert de pièce de liaison avec le châssis de la grue.
<b>Moteur</b>	Moteur Diesel, 4 cylindres, fabriqué par Liebherr, type D 924 TI-E A4, refroidi à l'eau, puissance 149 kW (202 PS) à 1800 min <sup>-1</sup> selon EPA/CARB et les directives 97/68 CE, étage 2, couple maxi 646 lbs/ft à 1150 min <sup>-1</sup> , réservoir de carburant: 74 gallons.
<b>Entraînement de la grue</b>	Diesel hydraulique avec 2 pompes à débit variable à pistons axiaux, servocommande et régulation de la puissance, 1 double pompe à engrenages, circuits hydrauliques ouverts et régulés. Entraînement hydraulique compact, accouplé directement au moteur Diesel, mécanisme d'entraînement total fermé pour une bonne insonorisation.
<b>Direction</b>	Direction électrique «Load Sensing», 4 mouvements de travail dirigeable simultanément, deux leviers de commande à 4 positions et à autocentrage.
<b>Mécanisme de levage</b>	Moteur à cylindrée constante et à pistons axiaux. Treuil de marque Liebherr équipé d'un engrenage planétaire et d'un frein d'arrêt commandé par ressort.
<b>Mécanisme de relevage</b>	1 vérin différentiel avec soupapes de retenu.
<b>Dispositif de rotation</b>	Moteur à cylindrée constante à pistons axiaux, engrenage planétaire, frein d'arrêt commandé par ressort.
<b>Cabine du grutier</b>	Construction en tôle d'acier entièrement zinguée avec peinture par poudrage et cuisson au four, avec glaces de sécurité, appareils de commande et de contrôle, équipement confortable, cabine inclinable vers l'arrière.
<b>Dispositif de sécurité</b>	Contrôleur de charge «LICCON», système test limitation de la course pour le levage, soupape de sûreté contre la rupture de tubes et de tuyaux.
<b>Flèche télescopique</b>	Flèche télescopique en acier à haute résistance à grains fins, à profil ovale, 1 élément de base et 5 éléments télescopiques. Tous les éléments télescopables indépendamment les uns des autres. Système de télescopage séquentiel rapide «Telematik». Longueur de flèche: 38 ft – 171 ft.
<b>Contrepoids</b>	Contrepoids principal de 26400 lbs.
<b>Installation électrique</b>	Technique moderne de transmission de données par BUS de données. Courant continu 24 Volts, 2 batteries de 170 Ah chacune.

## Equipment Équipement

### Équipement supplémentaire

<b>Fléchette pliante</b>	Longueur: 35 ft – 62 ft, montable sous un angle de 0°, 20° ou 40°. Vérin hydraulique pour le relevage de la fléchette pliante de 0° à 40° (en option).
<b>Rallonge flèche télescopique</b>	Élément en treillis de 23 ft – 46 ft, de cette manière point d'articulation plus haute de 23 ft – 46 ft pour la flèche pliante.
<b>2ème mécanisme de levage</b>	Pour l'utilisation du deuxième crochet, ou bien pour une utilisation avec fléchette pliante lorsque le câble de levage principal rest mouflé.
<b>Contrepoids supplémentaire</b>	22050 lbs pour un contrepoids total de 48500 lbs.
<b>Entraînement 8 x 8</b>	Essieu 1 est entraîné additionnellement.

Autres équipements supplémentaires sur demande.

